



HPS High-pressure nozzle system

Adiabatic humidification and cooling system



Operating Manual



HPS.EN
E-8881140

Certain computer programs contained in this product [or device] were developed by HygroMatik GmbH ("the Work(s)").

Copyright © HygroMatik GmbH [11.11.2021]

HPS High-pressure nozzle system

HPS.EN

All Rights reserved.

HygroMatik GmbH grants the legal user of this product [or device] the right to use the Work(s) solely within the scope of the legitimate operation of the product [or device]. No other right is granted under this licence. In particular and without prejudice to the generality of the foregoing, the Work(s) may not be used, sold, licensed, transferred, copied or reproduced in whole or in part or in any manner or form other than as expressly granted here without the prior written consent of HygroMatik GmbH.

Information in this manual is subject to change or alteration without prior notice.

▲ WARNING**Risk of electrical shock!**

Hazardous electrical high voltage!

All electrical work to be performed by certified expert staff (electricians or expert personnel with equivalent training) only.

1. Introduction	7
1.1 Typographic Distinctions	7
1.2 Documentation	7
1.3 Symbols in Use	7
1.3.1 Specific Symbols related to Safety Instructions	7
1.3.2 General Symbols	8
1.4 Intended Use	8
2. Safety Instructions	9
2.1 Guidelines for Safe Operation	9
2.1.1 Scope	9
2.1.2 Unit control	9
2.1.3 Unit Operation	9
2.1.4 Electrical	9
2.2 Disposal after dismantling	10
3. Transport	11
3.1 General information	11
3.2 Packaging	11
3.3 Interim storage	11
3.4 Check for Complete and Correct Delivery of Goods	11
3.5 Scope of delivery	11
4. Humidification chamber	12
4.1 Structural composition of a humidification chamber	12
4.2 Mechanical assembly Vortex wall	13
5. Composition and function of the HygroMatik high-pressure nozzle system HPS	14
5.1 Fields of application	14
5.2 Functioning	14
5.3 Schematic diagram of the system components	14
5.4 Control options (modes of operation)	15
5.4.1 Supply air humidification (standard operation)	15
5.4.2 Supply air humidification 2 load mode (normal requirements; comfort humidification) ..	15
5.4.3 Supply air humidification 3 load mode (process humidification)	15
5.4.4 Supply air humidification 4 load mode	16
5.4.5 Exhaust air cooling	16
5.4.6 Combined system	16
5.5 Main components	17
5.5.1 The unit cabinet and its internal assemblies	17
5.5.2 Overview on the electrical and electronic components of the system	17
5.5.2.1 High-pressure pump group	19
5.5.2.2 By-Pass	19
5.5.3 Vortex modules	20
5.5.3.1 Atomising nozzles for vortex modules	20
5.5.4 Aerosol separators	21
5.5.5 Humidification section	21

5.6 Flushing functions	21
6. Mechanical installation	22
6.1 Environment Parameters to be met and Mounting Recommendations	22
6.2 Unit installation	22
6.3 Unit connections	24
6.3.1 Dimensions and mounting instructions	25
7. Supply and waste water connections	26
7.1 Schematic view	26
7.2 Water inlet	27
7.2.1 Supply water quality	27
7.3 Water drain	27
7.3.1 Water drain of the humidification chamber	28
7.4 Water connection final check	28
8. Hygiene	29
8.1 Ensuring hygiene (VDI 6022)	29
8.2 Automatic flushing	29
8.3 Air feed for the nozzle system	29
9. Electrical connection	30
9.1 Electrical installation approach	30
9.2 Main connection	30
9.3 Safety (interlock) system	31
9.4 Inspecting the electrical installation	31
10. Commissioning	32
11. Description of control	35
11.1 General description	35
11.2 Layout of control	35
11.3 Mainboard	36
11.3.1 Connections on the mainboard	37
11.3.1.1 Customer-side interfaces	37
11.3.1.2 System-side interfaces	37
11.4 Expansion board	38
11.4.1 Connections of the expansion board	39
11.5 Connection terminals block	39
11.6 Electrical connection	40
11.6.1 Connection of control voltage	40
11.6.2 Connection of interlock (safety) system	40
11.6.3 Terminal wiring for the various modes of operation	41
11.6.3.1 Terminal wiring for supply air humidification (standard delivery)	41
11.6.3.2 Terminal wiring for a combined unit (ordering option)	42
11.6.4 General use of the digital input on the mainboard	43
12. Screen	44
13. Operation of control	46
13.1 Operation basics	46

13.2 Screen 1 - Commissioning	48
13.2.1 Setting the language	48
13.2.2 Input of date and time	48
13.2.3 Control settings	49
13.2.4 Line-up of the commissioning parameters	50
13.3 Screen 2 - Main screen	51
13.3.1 Changing the set point humidity	52
13.4 Password entry	53
13.5 Screen 3 - Main menu (basic level)	53
13.6 Basic level submenus	53
13.6.1 Settings submenu	55
13.6.2 Read values submenu	56
13.6.3 History submenu	58
13.6.3.1 Explanation of history management	58
13.7 Screen 3 - Main menu (advanced level)	60
13.8 Advanced level submenus	60
13.8.1 Settings submenu	61
13.8.2 Read values submenu	61
13.8.3 Control submenu	62
13.8.4 Service submenu	63
13.8.4.1 Service messages	63
13.8.4.2 Procedure for parameter update	64
13.8.5 History submenu	64
13.8.6 Functions submenu	65
13.8.6.1 Communication interface submenu	66
13.8.7 Adiabate submenu	67
13.8.8 Recording submenu	68
13.8.9 Submenu Cylinder extension *)	69
14. Faults	72
14.1 Fault Management	72
14.1.1 Table of fault messages, possible causes and countermeasures	72
14.2 Service messages	75
15. Maintenance	76
15.1 Maintenance activities	76
15.1.1 Changing the oil in the high-pressure pump	76
15.1.2 Checking/replacing the mains water filter	77
15.1.3 Flushing the mains water system	78
15.1.4 Cleaning the high-pressure nozzles	78
15.1.5 Cleaning the aerosol separators	79
15.1.6 Cleaning the spray system	79
15.1.7 Cleaning the mounting profiles	79
15.1.8 Cleaning the humidification chamber	79
15.2 Extended service instructions	80

- 15.2.1 Replacing the shaft sealing ring of the high-pressure pump EH2009 80
- 15.2.2 Replacing the valves 82
- 15.2.3 Replacing the seals on the water side 83
- 15.2.4 Calibration work after repair or replacement of the high-pressure pumpstation 84
 - 15.2.4.1 Setting of the overpressure protection 84
 - 15.2.4.2 Setting of the optional by-pass valve on the distribution manifold 84
- 16. Declaration of Conformity 85**
- 17. Spare parts 86**
- 18. Technical specifications 88**
- 19. Glossary 89**

1. Introduction

Dear Customer,

Thank you for choosing a HygroMatik high-pressure nozzle system HPS. „HPS“ stands for „High Pressure System“, i.e. , in question is a nozzle system that is operated with a pressure of 25 to 75 bar.

The HygroMatik high-pressure nozzle system HPS (referred to hereafter as „High-pressure nozzle system“) represents the latest in humidification technology.

In order to operate the high-pressure nozzle system safely, properly and efficiently, please read these operating instructions.

Employ your high-pressure nozzle system only in sound condition and as directed. Consider potential hazards and safety issues and follow all the recommendations in these instructions.

If you have additional questions, please contact your expert dealer.

For all technical questions or spare parts orders, please be prepared to provide unit type and serial number (see name plate on the unit).

1.1 Typographic Distinctions

- Preceded by a bullet: general specifications
- » Preceded by an arrow: procedures for servicing or maintenance which should or must be performed in the indicated order
- ☑ Installation step which must be checked off.

1.2 Documentation

Retention

Please retain these operating instructions in a secure, always accessible location. If the product is resold, turn the documentation over to the new operator. If the documentation is lost, please contact HygroMatik.

Versions in Other Languages

These operating instructions are available in several languages. If interested, please contact HygroMatik or your HygroMatik dealer.

1.3 Symbols in Use

1.3.1 Specific Symbols related to Safety Instructions

According to ANSI Z535.6 the following signal words are used within this document:

▲ DANGER

DANGER indicates a hazardous situation which, if not avoided, will result in death or serious injury.

▲ WARNING

WARNING indicates a hazardous situation which, if not avoided, could result in death or serious injury.

▲ CAUTION

CAUTION indicates a hazardous situation which, if not avoided, could result in minor or moderate injury.

NOTICE

NOTICE is used to address practices not related to physical injury.

1.3.2 General Symbols

Please note

This symbol is used whenever a situation requires special attention beyond the scope of safety instructions.

1.4 Intended Use

The high-pressure nozzle system is used for air humidification and cooling with desalinated water having a conductivity of 5-50 $\mu\text{S}/\text{cm}$.

Proper use includes fulfilment of the assembly, disassembly, reassembly, start-up, operating and maintenance conditions specified by us as well as disposal measures.

Only qualified and personnel may work on or with the system (a supplementary qualification according to VDI 6022 Part B or an equivalent qualification is recommended). Persons transporting or working on or with the system must have read and understood the relevant parts of this operating manual, particularly the 'Safety instructions' section. Staff must also be informed of possible hazards by the operating company. Please keep a copy of the operating manual at the location where the device is being used.

Applications:

The high-pressure nozzle system has a wide range of applications. These systems are used wherever low-energy adiabatic humidification or cooling or systems with high-precision control are needed. They can be found in such places as offices, storerooms, production halls, clean rooms, hospitals and concert halls.

NOTICE

Components installed in ventilation and air-conditioning systems must be suitable for the intended use; i.e. they must be corrosion-resistant according to VDI 6022 or equivalent, easy to clean, accessible and hygienic. Furthermore, they must not facilitate growth of microorganisms.

Improper use:

Any other use not compatible with the intended use outlined above is not allowable. Improper use as well as changes in hardware or software that are not authorized by HygroMatik will lead to the total loss of guarantee and warranty claims.

NOTICE**Operating conditions must be met at any time!**

- The nozzle system is not frost-proofed and not suitable for outdoor installation
- The room temperature should lie between 5 and 40 °C
- When attempting to operate the system in a position higher than 1000 m above sea level, pls. talk to HygroMatik prior to installation
- The pressure level of the nozzle system must not be changed without the consent of HygroMatik GmbH
- The nozzle system must not be used for cold water cooling without the consent of HygroMatik GmbH
- The nozzle system must not be operated with a vertical flow without the consent of HygroMatik GmbH

Please note

For hygienic reasons (legionella prevention), the feed water temperature should not exceed 15 °C.

2. Safety Instructions

These safety instructions are required by law. They promote workplace safety and accident prevention.

2.1 Guidelines for Safe Operation

2.1.1 Scope

Comply with the accident prevention regulation „DGUV Regulation 3“ to prevent injury to yourself and others. Beyond that, national regulations apply without restrictions.

2.1.2 Unit control

Do not perform any work which compromises the safety of the unit. Obey all safety instructions and warnings present on the unit.

In case of a malfunction or electrical power disruption, switch off the unit immediately and prevent a restart. Repair malfunctions promptly.

▲ WARNING

Restricted use.

IEC 60335-1 stipulates as follows:

This device may be used by children of eight years of age and above as well as by persons with reduced physical, sensory or mental capabilities or lack of experience and knowledge so long as they are supervised or have been instructed regarding the safe use of the device and understand the hazards that may result from it. Cleaning and user maintenance of the unit must not be undertaken by children without supervision.

2.1.3 Unit Operation

▲ WARNING

Health hazard due to the inhalation of aerosols.

During operation of the HygroMatik high-pressure nozzle system HPS, it is not permitted to stay in the humidifier chamber.

▲ WARNING

Health hazard

The demineralized water required for the operation of the high-pressure nozzle system is not suitable for drinking.

NOTICE

Risk of material damage!

The unit may be damaged if switched on repeatedly following a malfunction without prior repair.

Rectify defects immediately!

Regularly check that all safety and monitoring devices are functioning normally. Do not remove or disable safety devices.

2.1.4 Electrical

▲ WARNING

Risk of electrical shock!

Hazardous electrical voltage!

Any work on the electrical system to be performed by certified expert staff (electricians or expert personnel with comparable training) only.

During maintenance or installation work, the device must be disconnected from the power supply and secured against being switched on again. The absence of voltage must be ensured by a measurement.

After electrical installation or repair work, test all safety mechanisms (such as grounding resistance).

NOTICE

Use only original fuses with the appropriate amperage rating.

Regularly check the unit's electrical equipment. Promptly repair any damage such as loose connections or burned wiring.

Responsibility for intrinsically safe installation of the high-pressure nozzle system is incumbent on the installing specialist company.

2.2 Disposal after dismantling

The humidifier is made up of metal parts and plastic parts. In reference to European Union directive 2012/19/EU issued on 4 July 2012 and the related national legislation, please note that:

The components of the electrical and electronic devices must not be disposed of as municipal waste, and therefore the method of waste separation must be applied. The public or private waste collection systems defined by local legislation must be used.

NOTICE

The operator is responsible for the disposal of unit components as required by law.

3. Transport

3.1 General information

Please note

Take care when transporting the high-pressure nozzle system to prevent the device and packaging from being damaged by impact or accidental loading or unloading.

3.2 Packaging

The high-pressure nozzle system is delivered on a pallet.

3.3 Interim storage

Store the unit in a dry place and protect from frost and strong sunlight.

Please note

Only clean components may be installed in a ventilation duct.

3.4 Check for Complete and Correct Delivery of Goods

Upon receipt of the unit, confirm that:

- model and serial number on the name plate match those specified in the order and delivery documents
- the equipment is complete and all parts are in perfect condition

Please note

In case of damage from shipment and/or missing parts, immediately notify the carrier or supplier in writing.

Time limits for filing freight claims with shipping companies are*:

Shipping company	After receipt of goods
Carriers	no later than 4 days
Parcel service	immediately

* Time limits for some services subject to change.

3.5 Scope of delivery

The following items are included in the delivery:

- spray system
- aerosol separators
- high-pressure pump station
- operating instructions for the system

4. Humidification chamber

4.1 Structural composition of a humidification chamber

The fig. hereafter schematically shows the composition of a vortex module wall and two aerosol separators in a humidification chamber with the hygienic and safety prerequisites required (drains, darkenable inspection window).

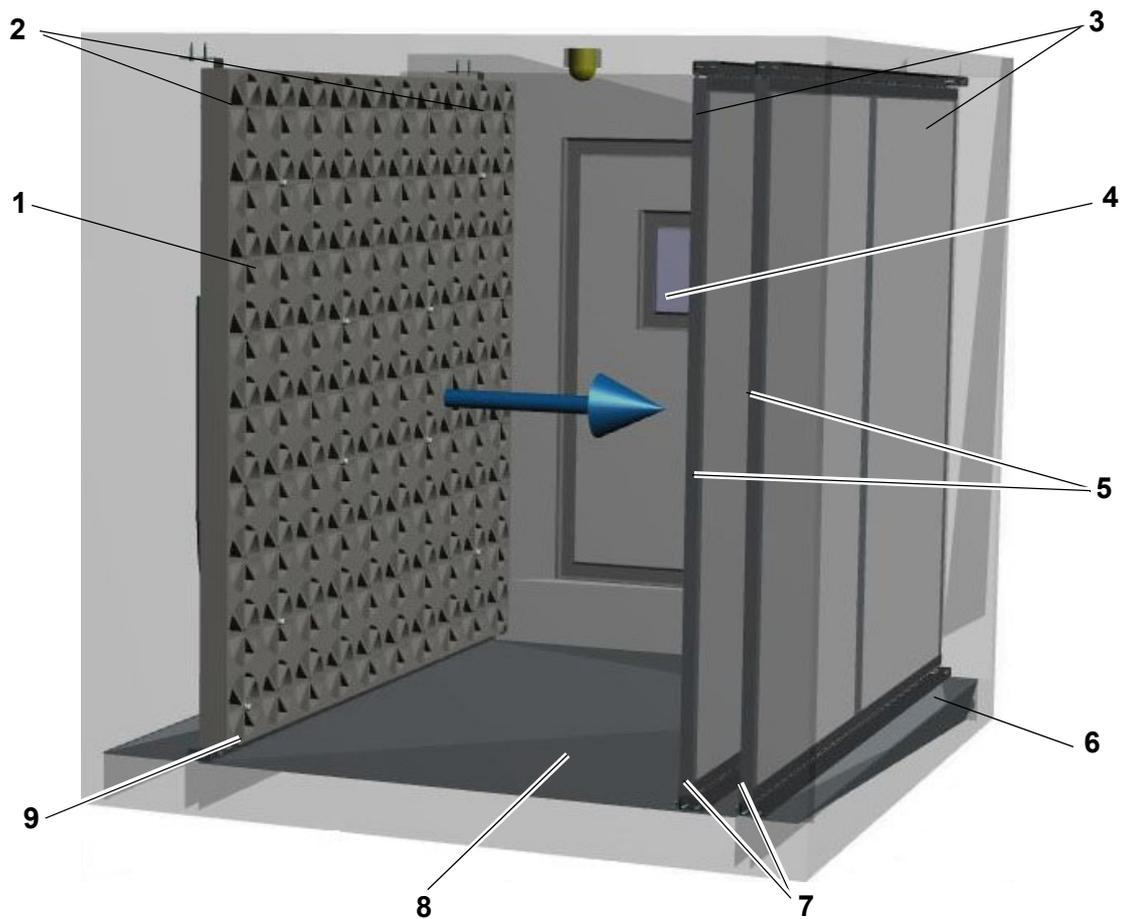

1	vortex module wall with spray system	6	drain with trap, free draining
2	upper mounting angle pieces for spray system	7	lower guide rails for aerosol separators
3	upper guide rails for aerosol separators	8	collection tray
4	inspection window, darkenable	9	lower guide rail for spray system
5	aerosol separators		

4.2 Mechanical assembly Vortex wall

This section is for the company in charge of the duct installations. For the operator of the nozzle system, the following remarks are for information only.

Please note

The installation of the device and the humidifier chamber may only be carried out by personnel with appropriate expertise.

HygroMatik accept no liability for damages resulting from incorrect assembly.

The assembly of the spray system and the integration of the aerosol separators in the humidification chamber are described in detail in the „Installation and initial operation instructions for HygroMatik adiabatic humidification systems“ document. Following below is a line-up of the bullet points for overview purposes:

- The guide rails and mounting angle for the vortex module wall and aerosol separators can be supplied on-site. The guide rails must already be installed before system start-up. Also, the vortex module wall and aerosol separators must already be installed
- The guide rails must be designed in a way that the vortex module wall and aerosol separators can be removed (for servicing)
- The humidification component should be built like a scrubber housing with a decline of at least 1.5° towards the trap (siphon) and should be waterproof
- The water outlet must feature siphon and allow for free draining
- The humidification chamber should be aerosol-tight and it should be able to withstand desalinated water.
- The minimum humidification section length (distance between spray system and aerosol separators) is 0.9 m. This corresponds to a total installation length of 1.5 m (see fig. 2 in the „Instal-

lation and initial operation instructions for HygroMatik adiabatic humidification systems“ document). Should this installation length not be feasible, please contact HygroMatik

- Next to the spray system and the droplet separators (in direction of the humidification chamber walls), a minimum distance of 0.5 m to other installed components must be maintained
- The air flow must be laminar. i.e. in case of a fan installed upstream of the spray system, a minimum distance of 1.0 m must be obeyed or other measures must be taken
- Ensure that after installation the humidification chamber is leakage-free
- Before initial start-up of the system check again that the humidification chamber has been thoroughly cleaned. In particular the humidification chamber and the ventilation duct upstream of the chamber must be free from metal swarfs to prevent corrosion

NOTICE

Risk of material damage to the vortex module due to excessive temperature.

The vortex modules must not be exposed to temperatures >60 °C.

Please note

Mounting or insertion of additional equipment is only permitted with the written consent of the manufacturer. Otherwise the guarantee and warranty will become void.

5. Composition and function of the HygroMatik high-pressure nozzle system HPS

5.1 Fields of application

Typical application of the high-pressure nozzle system is the humidification of an supply air stream. As an order option, a particular unit variant is available that is used for exhaust air cooling. An other order option is the „Combined system“ that supports both operation modes. In a combined system, the actual operation is determined by the terminal wiring that usually encompasses a switch for mode selection.

5.2 Functioning

The high-pressure nozzle system is based on atomisation of water.

Desalinated water is fed into a high-pressure piston pump. With an operating pressure of up to 75 bar, the water is atomized by means of high-pressure nozzles. These nozzles generate a very fine spray mist which is taken up by the air in the humidification chamber. The ambient air is cooled adiabatically in the process

5.3 Schematic diagram of the system components

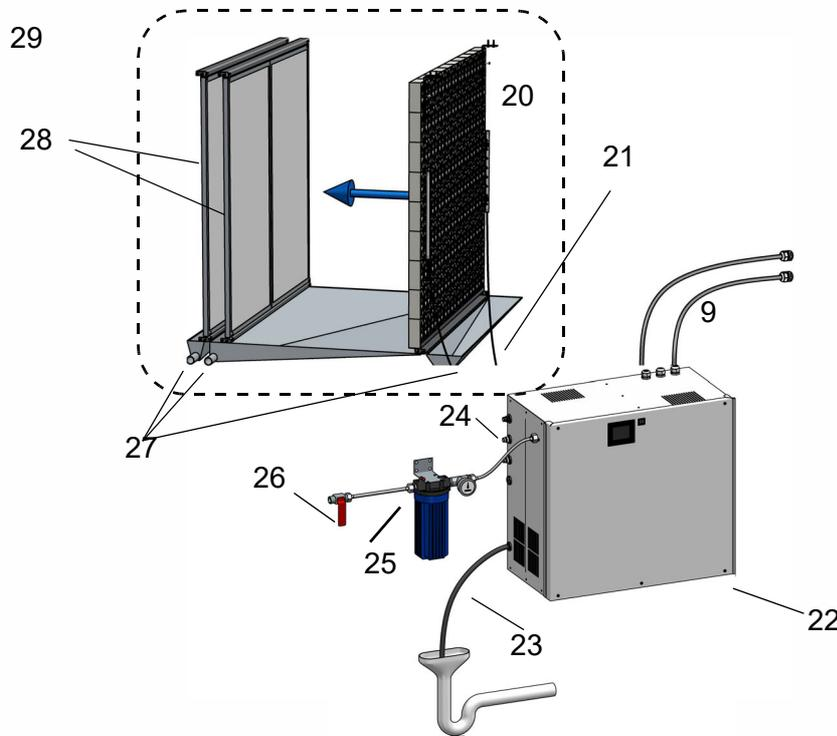

9	Electrical connections	25	Water filter with pressure gauge
20	spray system (exemplarily shown with two nozzle segments)	26	Water supply via cock
21	pressure hoses, max. length 15 m (49 ft.)	27	Water drains (siphoned)
22	high-pressure pump group, control	28	aerosol separator (2 step), exemplary
23	1¼" water drain hose to free running tap	29	Installation in humidification cabin with darkening window (according to VDI 6022) and water tray or in a duct with service doors and water tray
24	water supply connection hose		

5.4 Control options (modes of operation)

The usability of the modes of operation described below depends on the actually available physical system implementation, i.e. the number of available nozzle sections. On the other hand, the system must be engineered for the respective number of loads. The number of loads required was specified when the system was ordered.

Basic prerequisite for operating the system is the enabling via the safety (interlock) system (terminals 1/2 on terminalblock X1) by a max. hygrostat or other on-site disengaged locking mechanisms.

5.4.1 Supply air humidification (standard operation)

For controlling the system, an on-site control signal of 0...10 V (0...20 mA / 0...140 Ω) is required. All nozzles provided are driven with an atomisation pressure of 25...75 bar proportionally following the resulting actuator signal. The system reaches maximum possible humidification output at 100 percent of the drive signal.

5.4.2 Supply air humidification 2 load mode (normal requirements; comfort humidification)

This mode is only available on a system featuring at least 2 independent nozzle sections.

For controlling the system, an on-site control signal of 0...10 V (0...20 mA / 0...140 Ω) is required that is transformed in an internal actuator signal by the control electronics.

In the range from 0 to approximately 50 percent of the actuator signal, only one nozzle section is driven with an atomisation pressure of 25...75 bar. This range is called „1st load“.

When the actuator signal reaches 50 percent plus **hysteresis** (switching point 1 plus hysteresis), the pumping station switches on the second nozzle section and reduces the pressure to 25 bar. Up to an actuator signal of

100 percent, the output pressure on the nozzles rises proportionally up to 75 bar and the system reaches the maximum possible humidification output. Beyond the switching point the system works in the „2nd load“.

Hysteresis of the switching thresholds is essential in order to prevent the control from oscillating. It is relevant for all of the load switching points, i.e. for more than 2 loads as well. Factory setting is 1.0%, i.e. the threshold for switching to the 2nd load mode is 51 % upwards and 49 % downwards.

5.4.3 Supply air humidification 3 load mode (process humidification)

This mode is only available on a system featuring at least 3 independent nozzle sections. For controlling the system, an on-site control signal of 0...10 V (0...20 mA / 0...140 Ω) is required that is transformed to an internal actuator signal.

In the range from 0 to approximately 30 percent of the actuator signal (switchpoint 1), only one nozzle section is driven with an atomisation pressure of 25...75 bar, the so called „1st load“. When the actuator signal exceeds this level, the pumping station switches on the second nozzle section and reduces the pressure to 25 bar. Beyond that up to approximately 60 percent, the nozzle output pressure is proportionally increased until it reaches its maximum of 75 bar. This is the range of the „2nd load“. Beyond that level the third nozzle section is switched on („3rd load“) while the pressure is decreased to 25 bar again. Up to an actuator signal of 100 percent, the output pressure on the nozzles rises proportionally up to 75 bar and the system reaches the maximum possible humidification output.

5.4.4 Supply air humidification 4 load mode

The 4-load-configuration allows for exact humidification controllability even in the range of minimum output demand.

A prerequisite for this mode of operation is the availability of 4 independent nozzle sections. For controlling the supply air humidification, an on-site control signal of 0...10 V (0...20 mA / 0...140 Ω) is required that is transformed to an internal actuator signal.

In the range up to approximately 12.5 percent of the actuator signal (switching point 1), only one nozzle section is driven with an atomisation pressure of 25...75 bar, the so called „1st load“. Beyond that level, the pumping station switches on the second nozzle section and reduces the pressure to 25 bar. Following this, with rising humidification demand, up to approximately 25% of the actuator signal, the atomisation pressure is proportionally increased up to the maximum of 75 bar („2nd load“).

Beyond this, the third nozzle section is switched on („3rd load“) while the pressure is decreased to 25 bar again. The further increase of the actuator signal up to approximately 50%, the atomisation pressure is proportionally increased to 75 bar.

Beyond the 50 percent, the fourth nozzle stage is also switched on („4th load“) and the atomisation pressure is reduced again to 25 bar. With the control signal now rising up to 100 percent, the atomisation pressure rises to 75 bar and the system reaches maximum possible humidification output.

5.4.5 Exhaust air cooling

The high-pressure nozzle system was either ordered as an exhaust cooling system or can be put to exhaust air cooling operation mode by (switched) wiring, when a combined system was ordered (s. section 4.4.6). As a control signal, the whole variety is available that is possible for the control supply air humidification mode. In contrast to the supply air humidification mode, exhaust air cooling comprises no load switching.

The purpose of the extract air cooling is to transfer maximum cooling capability into the supply air flow (heat exchanger provided by customer), to support air conditioning systems. In this type of application humidification is typically 95 to 100 percent. All nozzles are immediately supplied with maximum power when the system is enabled. If the humidity switch or another sensor detects that cooling is no longer necessary the enabling is cancelled and the system goes to stand-by mode.

5.4.6 Combined system

A combined system allows for switching between supply air humidification and exhaust air cooling. Supply air humidification can be run in the „Standard“, „2-load“ and „3-load“ modes with the full variety of control signals that are supported by a dedicated system. When exhaust air cooling is selected, however, only 1-step operation is possible.

5.5 Main components

5.5.1 The unit cabinet and its internal assemblies

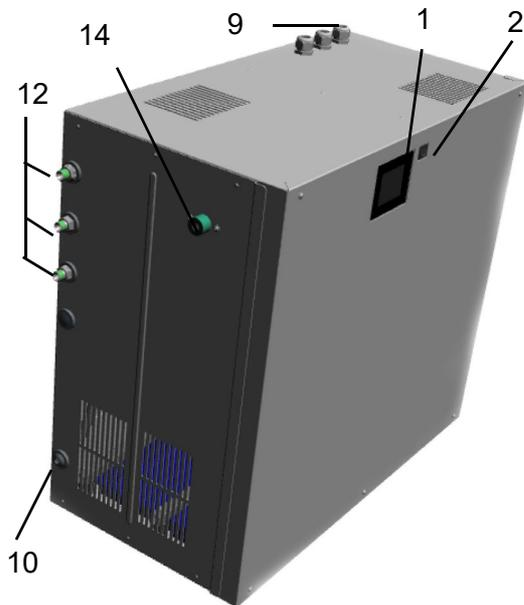

- 1: touchscreen
- 2: main switch
- 9: cable entries
- 10: drain connection 12 mm
- 12: outlets to the nozzles
- 14: water connection 3/4"

5.5.2 Overview on the electrical and electronic components of the system

In the unit cabinet, the electrical and electronic components as well as the wiring terminals are installed below a hinged lid. The electronic control unit is responsible for control of the system.

The touch screen shows relevant operational data and allows for parameter settings. The frequency converter produces the waveforms for the asynchronous motor of the pumpstation mounted in the lower part of the unit cabinet.

The main switch is for switching the high-pressure nozzle system on and off.

Construction of the High Pressure System

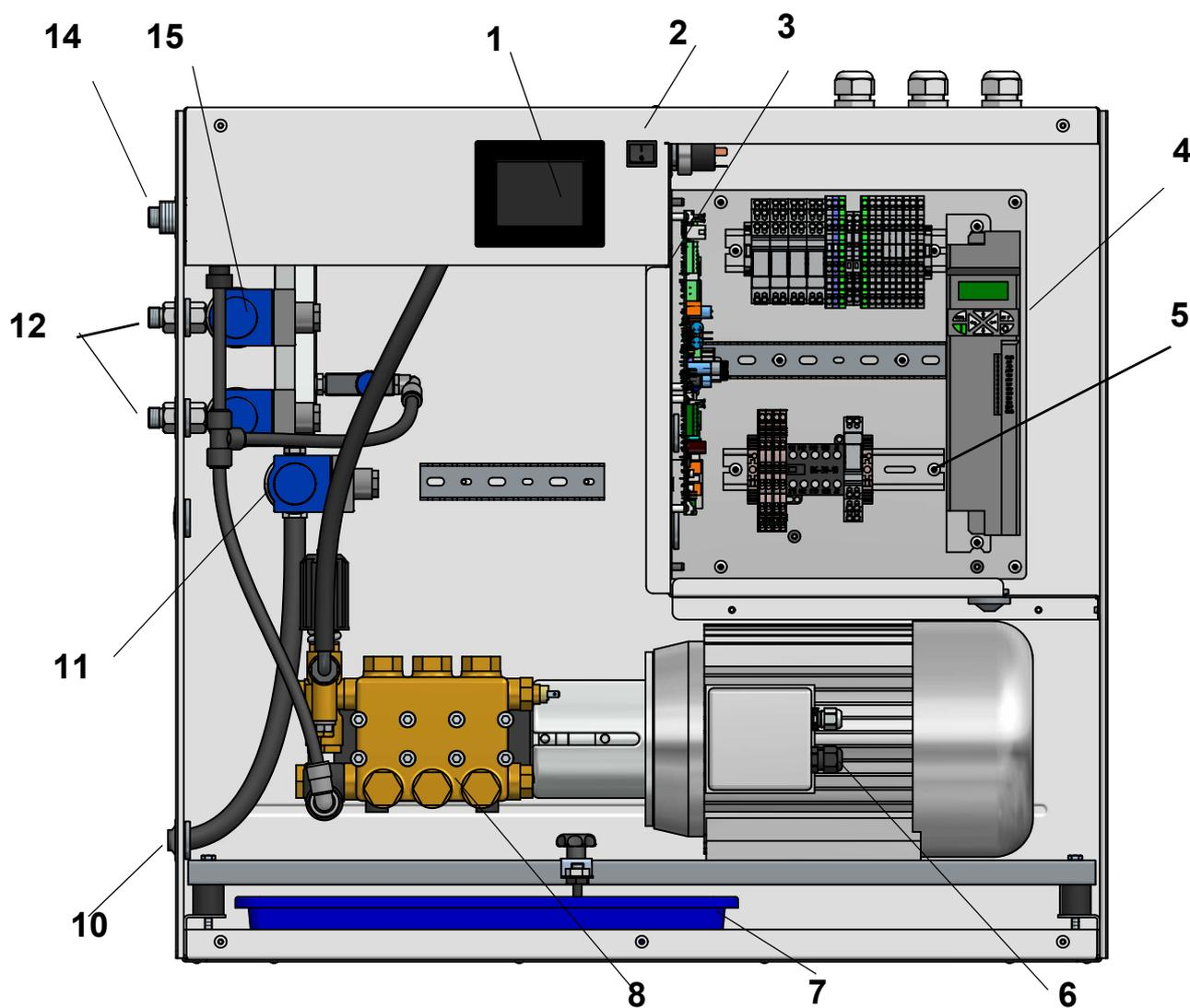

1	Touchscreen of the electronic control	8	High-pressure pump
2	Main switch	10	Wastewater connection 12 mm
3	Electronic control	11	Flushing solenoid
4	Frequency converter	12	Outlets to the nozzles
5	Main contactor	13	Water inlet solenoid, covered
6	Pump motor	14	Water connection 3/4" (hidden in fig.)
7	Collecting tray for leaks (water/oil)	15	Solenoid valves for nozzles

The main switch serves for switching the high-pressure system on and off. A frequency converter provides the variable frequencies and voltages for the asynchronous motor of the pump station. The pressure water is fed into a manifold with solenoid valves controlling the ports towards the humidification chamber.

The electronic control manages the system control. The touch screen enables the operating of the unit and the programming of parameters. The display is used for monitoring operating data and parameter settings.

5.5.2.1 High-pressure pump group

The high-pressure piston pump generates a pressure of up to 75 bar.

The maintenance-free variable frequency-driven asynchronous motor enables continuous operation up to 50 Hz. Depending on the speed of the pump, water

pressure and, consequently, the amount of atomized water may be varied. Water pressure is in the range from 25 to 75 bar allowing for the optimum mix of throughput and aerosol size.

Pump group	max. feed output [l/h]	humidification output [kg/h] @ 95 % efficiency rate	max. speed [rpm]
HPS250	260	46 - 250	1400
HPS500	620	90 - 600	1400

Pump station characteristics for the various unit models

5.5.2.2 By-Pass

Task of the by-pass is to ensure the minimum speed of the high-pressure pump even in case of very low humidification demand. Compliance with the minimum speed is essential for the pump lubrication and, as such, has direct impact on the pump's life expectancy.

Units not achieving their expected output capacity due to the limitation introduced by the by-pass valve feature a switched mode for operation under the highest load condition, i.e. a solenoid valve controlled by relay K21 cuts the by-pass flow.

5.5.3 Vortex modules

The vortex modules provide for effective mixing of the air and water mist.

Due to their special design, they generate turbulence and shear zones which lead to a homogeneous distribution of aerosols along the humidification section (min. 0.9 m).

The vortex modules (dimensions: 150 x 150 mm) are delivered individually and can be assembled to form a wall. For optimal moisture absorption, the air velocity is 0.9...2.8 m/s. The vortex module wall exhibits a low pressure drop of 80 Pa at an air velocity of 2.0 m/s.



Vortex module

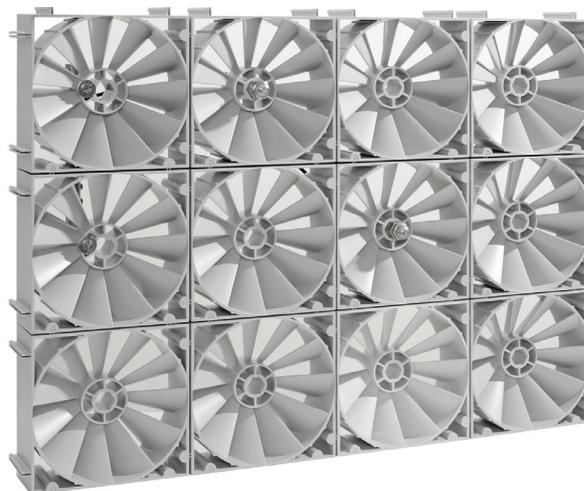

Vortex modul wall

5.5.3.1 Atomising nozzles for vortex modules

Desalinated water at a pressure of 25 to 75 bar reaches the high-pressure nozzles where the water is atomised to form ultra-fine mist-like aerosols. The aerosols enter the area of the vortexed air stream downstream of the vortex modules. The air and aerosols are mixed intensively here.

Two different types of atomising nozzles are used: atomising nozzles with a spray angle of 120° for general application and those for the edge areas of the vortex module wall featuring a spray angle of 60°.

Functioning:

Water is forced with high velocity into circulation by the swirl insert of the nozzle. Thereby the required atomisation of water into extremely fine aerosols takes place at the outlet opening.

The high operating pressure of the water (up to 75 bar) is nearly completely translated into the exit velocity from the nozzle. The higher the operating pressure the finer the droplets.

Material of the high-pressure nozzle: St. 1.4404

Spray characteristics operating pressure of 75 bar

- Volumetric flow rate: 7,1 l/h *)
- High percentage of droplet distribution in the range of 6-35 µm

*) Information is subject to change or alteration without prior notice

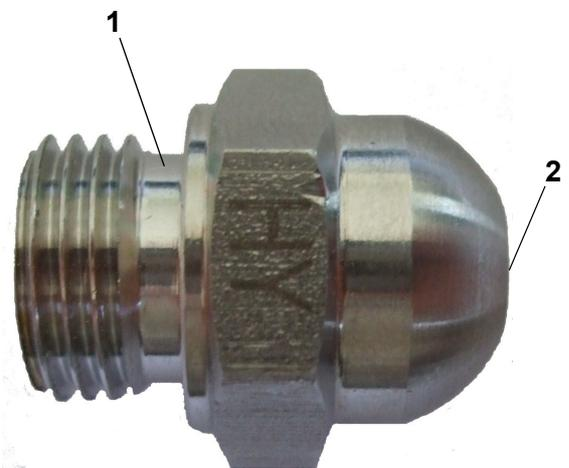

1 - nozzle body 2 - nozzle opening

5.5.4 Aerosol separators

There are no more atomised water droplets in the air stream behind the HygroMatik high-pressure nozzle system (if the environmental parameter specifications are complied with). For this purpose the aerosol separators are used that may be configured in a 1-step or 2-step arrangement, depending on the application requirements.. The dry trap pads exhibit a low pressure drop (30 Pa per stage at an air velocity of 2.0 m/s and an average air density of 1.2 kg/m³).

Specified environmental parameters

Air velocity: 0,9 – 2,8 m/s

relative humidity: 5 – 95% r.F.

Temp IN: 20 - 60°C

Temp OUT: min. 15°C

If it is outside this range it can cause moisture breakthrough downstream of the aerosol separators - in such cases please first contact HygroMatik.

The aerosol separators are inserted into the humidification chamber via guide rails and are hence easy to remove for servicing.

5.5.5 Humidification section

The section between the spray system and the aerosol separators is called the 'humidification section' in this system. It is unobstructed and hence easy to monitor and clean.

Please note

It is recommended that the humidity sensor is mounted in a distance of at least 5 m with respect to the humidification system.

For a total standard installation length of 1.5 m for the HygroMatik high-pressure nozzle system the humidification section should have a length of at least 0.9 m. If this is not the case, pls. contact HygroMatik.

5.6 Flushing functions

The nozzle system offers a number of flushing variants in order to cope with the hygienic and maintenance oriented requirements. Flushing can be accomplished with supply water pressure only or through use of the vane pump, depending on a parameter setting. Also, the duration of the flushing function may be altered by the setting.

The following flushing variants are supported:

Manual flushing

Manual flushing is started by setting a parameter in the „Adiabate functions“ function group and stopped by resetting the parameter. The water inlet solenoid valve and the flushing valve are both opened.

Dead leg flushing

Dead leg flushing is to prevent microbial contamination due to water resident in the water supply. When dead leg flushing is activated, after a wait time defined by a parameter, a fully automatic flushing of the system is accomplished with line pressure while the inlet solenoid and the flushing solenoid are open. It is not required that the safety (interlock) system is closed for that purpose. The duration of the flushing may be varied by the setting of a parameter.

Hygiene flushing

The need for hygiene flushing comes from VDI 6022. After a settable wait time with no demand present, the whole water system with all of the nozzle segments must be flushed (VDI 6022 requires that the wait time is not longer than 48 hours).

Optimized flushing on demand

Internal algorithms in the control program monitor the operating conditions and trigger the flushing of the nozzle segments for humidification or the nozzle segment for cooling (if present). These flushings follow a sequence that is predefined in the control program.

6. Mechanical installation

▲ WARNING

Risk of foot injuries!

Prevent unit from dropping during installation! Helping hand of a second person is advisable.

▲ WARNING

Risk of electrical shock!

Hazardous electrical voltage. During installation, the unit must be disconnected from power supply and secured against being switched on again. The absence of voltage must be ensured by a measurement.

6.1 Environment Parameters to be met and Mounting Recommendations

When selecting the installation site for the HPS unit, take the following into account:

- Protection class IP20
- By design, HygroMatik steam humidifiers are not qualified for outdoor installation (electrical components and water-bearing parts may be damaged)
- Ambient temperature must lie between +5 and +40 °C (+41 and +104 °F) in order to protect the unit electronics against damage; frost may damage the steam cylinder, the solenoid valve and pump, as well as make hoses burst
- Relative humidity must not exceed 80 % r.h., since values beyond may lead to electronic malfunction or damage
- Installation in a closed room requires aeration and, eventually, temperature conditioning in order to meet the a.m. environmental conditions
- Make use of existing water connections for supply and draining

- The on-site waste water connection must be a free outlet according to DIN EN 1717.
- The installation room must be properly ventilated and equipped with a floor drain. Alternatively, a water stop device (e.g. leakage detector) can be used.
- Use genuine spare parts only
- After any repair work, have qualified personnel check the safe operation of the unit
- Attaching or installing of **additional components** is permitted only with the **written consent** of the manufacturer

NOTICE

The high-pressure nozzle system is IP20 protected. Make sure that the unit is not object to dripping water in the mounting location.

6.2 Unit installation

HygroMatik HPS units are designed for wall mounting. The unit should be mounted on a stable wall. Due to the high weight of the unit, the wall bracket included in the scope of delivery must be used.

If no suitable wall is available, this bracket can be used for floor mounting as an alternative. In this case the bracket is assembled differently and screwed to the floor.

NOTICE

The screws supplied are designed for mounting on a concrete wall/floor. Should you find other local conditions, please use appropriately adapted mounting material.

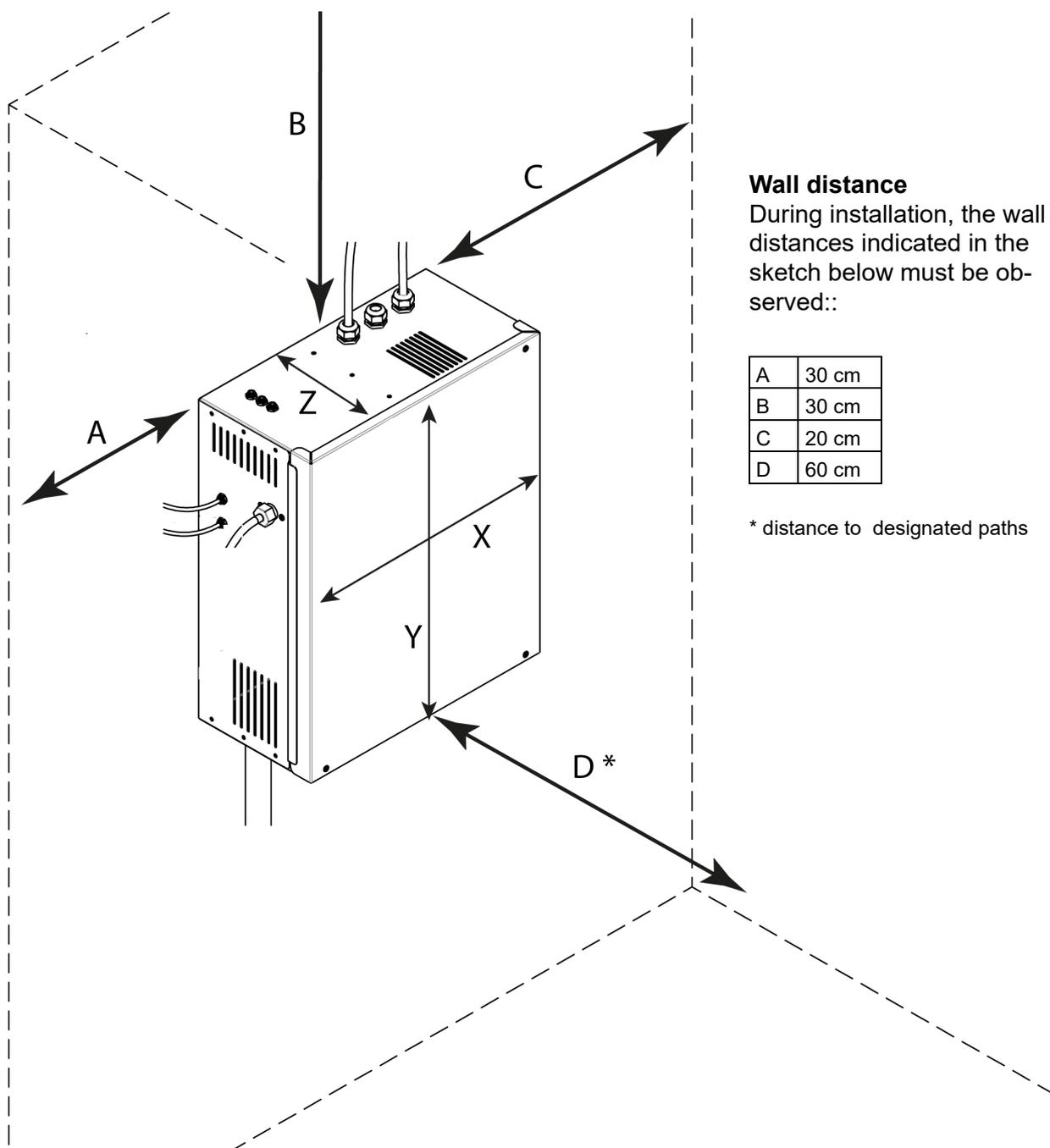

Wall distance

During installation, the wall distances indicated in the sketch below must be observed::

A	30 cm
B	30 cm
C	20 cm
D	60 cm

* distance to designated paths

Installation steps Wall mounting:

- » Mark the drill holes for the screws of the wall bracket
- » Drill and dowel holes
- » Fix the bracket (1*+2*) with the supplied mounting screws
- » Check that the mounted bracket is firmly seated and that it can take the load!
- » Insert the sound-absorbing buffers (3*) into the base holes of the HPS pump station and fasten them
- » Insert the pump station into the wall console and screw it tight

wall mounting

floor mounting

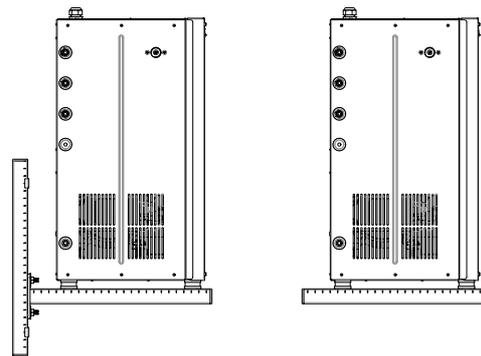

Installation steps Floor mounting:

- » Mark the holes for the screws of the bracket on the floor
- » Drill and dowel holes
- » Fix mounting rails (1*) with the supplied mounting screws
- » Check the tight fit and load capacity of the mounted bracket!
- » Insert the sound-absorbing buffers (3*) into the base holes of the HPS pump station and fasten them



- » Insert the pump station into the wall console and screw it tight

NOTICE

Tighten the screw connection only so firmly that the system can no longer slip. The sound absorbing buffers must not be squashed completely, otherwise they lose their sound absorbing properties

6.3 Unit connections

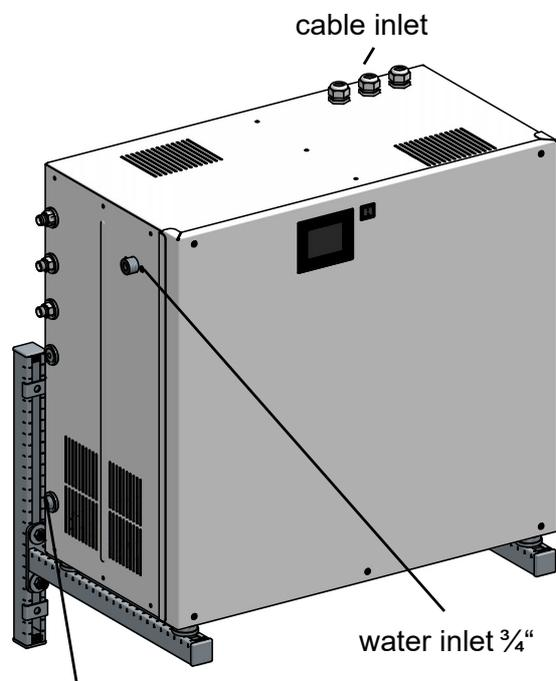

drain connection 12 mm (0,47 Inch)

6.3.1 Dimensions and mounting instructions

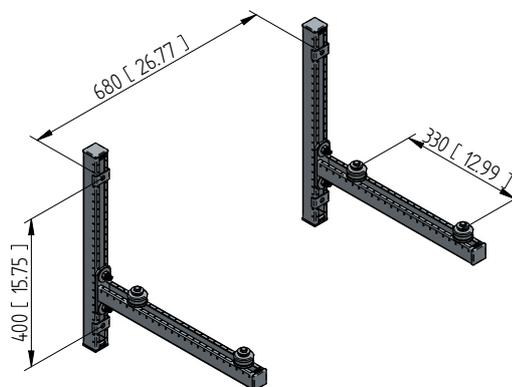
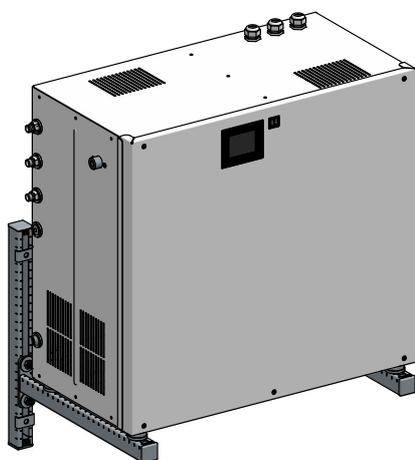
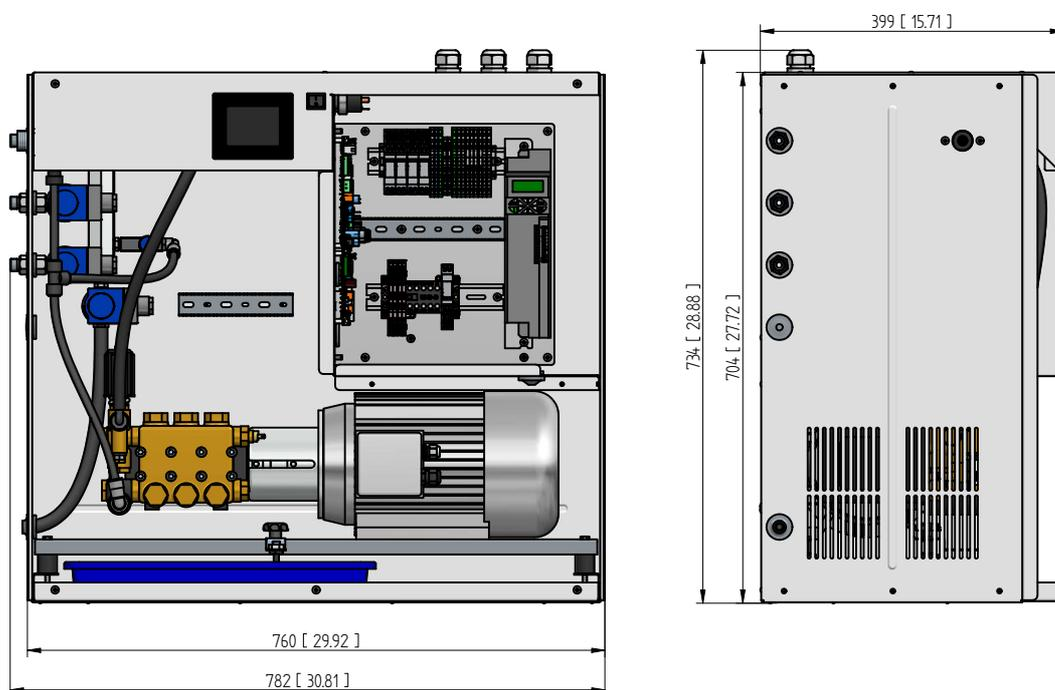

7. Supply and waste water connections

⚠ WARNING

Risk of electrical shock!

Hazardous electrical high voltage!
Before starting installation work ensure that the unit is not yet connected to the power supply.

General rules

- Obey local water utility regulations
- Have all installation work done by expert staff (plumber or personnel with comparable expertise)
- If desalinated water is used we recommend that stainless steel or plastic pipes be used
- We recommend designing the last segment of the water pipe to be flexible to prevent translation of vibration from the high-pressure pump group to the pipe-work
- All hygienic requirements must be met (s. section 6.2.1 Supply water quality)

7.1 Schematic view

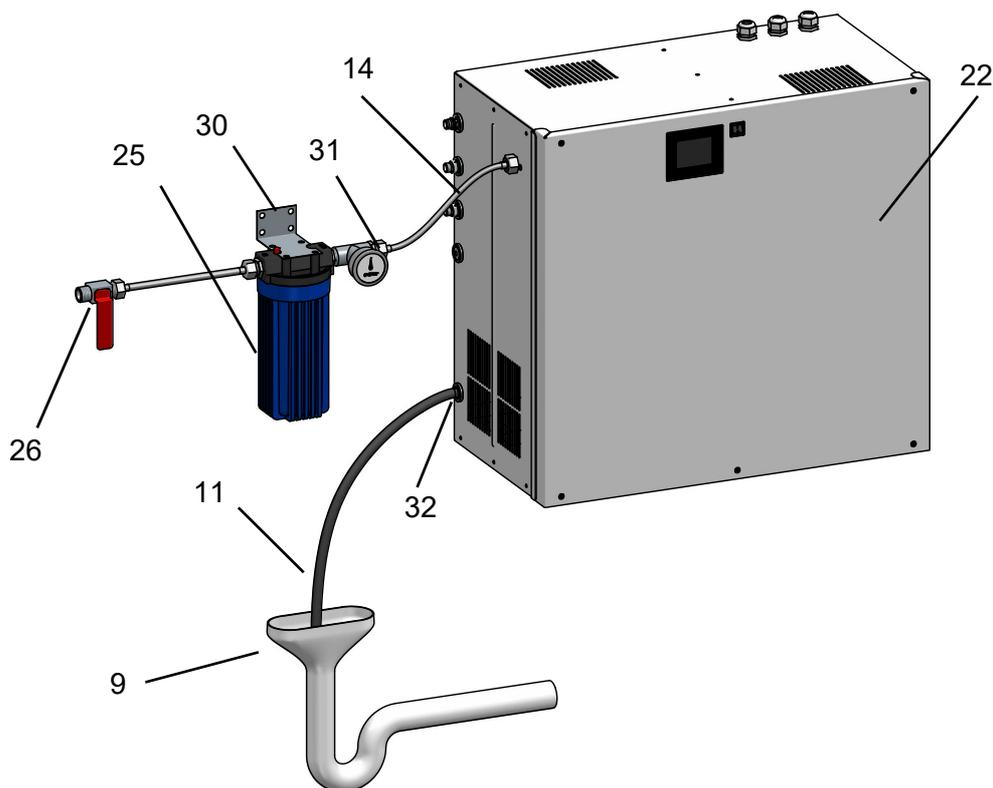

9	external drain with tap (free discharge required)	25	water filter (intake and outtake with 3/4" external thread) pressure gauge 0...10 bar
11	DN 12 hose, length approx. 85 cm (33.5")	26	water supply with cock
14	3/4 " water connection hose	30	mounting bracket
22	pump station with control	31	T-piece (part of water connection set)
		32	grommet

7.2 Water inlet

For the supply water feed, a connection piece with a 3/4 " external thread is located on the left unit housing wall.

Mount waterfilter close to pump station following these steps:

- » Transfer mounting bracket hole pattern to a suitable location on wall.
- » drill holes, dowel and attach mounting bracket with the mounting material included with the water filter.
- » Screw T-piece included in water connection set to water filter outlet and affix pressure gauge.
- » Connect open T-piece outlet with pump station using the water connection hose supplied.
- » Connect the external feed water line to the input side of the water filter (3/4 " external thread).

NOTICE

The screws supplied are designed for mounting on a concrete wall/floor. Should you find other local conditions, please use appropriately adapted mounting material.

7.2.1 Supply water quality

Please note

The supply water for the high-pressure nozzle system must comply with VDI 6022; i.e. from a microbiological point of view it must be of drinking water quality.

A flameresistant sampling tap is to be provided on-site in the direct vicinity of the HygroMatik high-pressure nozzle system.

Conductivity: 5...50 µS/cm

Pressure: 0.1...0.5 MPa (1...5 bar)

Volume flow: greater than the max. transportation capacity of the high-pressure nozzle system

Temperature: 5...15 °C

pH value: 7 +/-1

7.3 Water drain

On the left side of the unit housing a DN12 plastic hose is fed out. The water drain is used for:

- emptying and relieving the high-pressure lines to the vortex module wall after the enabling signal has been removed
- draining the flushing water from the feed water line in a flushing process

Design of the water drain

The DN12 water drain hose must show a constant decline towards the drain, must include a siphon and allow for free draining.

7.3.1 Water drain of the humidification chamber

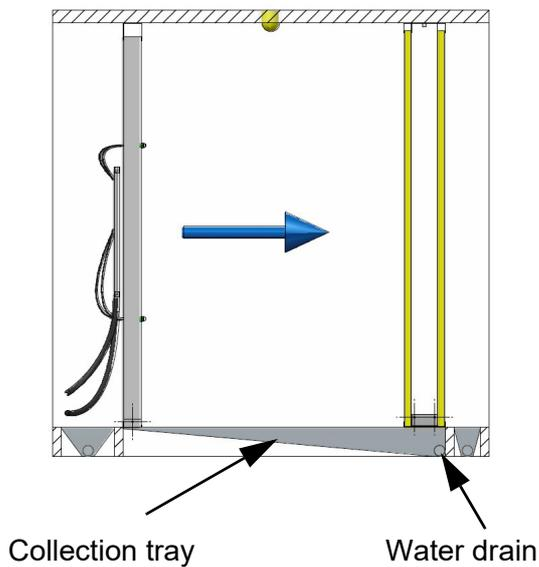

The water drain must be located at the lowest point of the collection tray and must feature a siphon. The water downstream of the siphon must drain off freely.

7.4 Water connection final check

Water supply

- Was the water filter insert supplied as part of the delivery installed in the water filter housing of the pumpstation?
- Is the feed water quality within the prescribed range?

Water drain

- Is the drain hose siphoned and installed with a constant decline towards the drain?
- Can the flushing water drain off freely?

Humidification chamber

- Is the humidification chamber provided with a drain at the lowest point of the collection tray?

8. Hygiene

8.1 Ensuring hygiene (VDI 6022)

The regulations require that only inert materials must be used and biocides should only be used as a last option.

A metal filter made of mesh wire is used as a aerosol separator.

The aerosol separators can - if necessary - be easily cleaned and reused. Addition of a biocide is not required.

All components must be easily accessible in order to allow for cleaning as required by VDI 6022.

8.2 Automatic flushing

According to VDI 6022, flushing of the system is required regularly within a 48 h time frame if no demand calls for the system operation. To meet this requirement, the HPS control initiates automatic flushing every 24 hours in order to prevent microbial contamination in standing water.

In this situation, a momentary increase of humidity in the air conditioning system may happen. Thus, in order to warrant the drying of the air condition system after flushing, the regular operation must be ensured.

8.3 Air feed for the nozzle system

Please note

The air flow must be laminar, i.e. in case of a fan installed upstream of the spray system, a minimum distance of 1.0 m must be obeyed or other measures must be taken.

Air purity

A pre-filter according to ISO ePM1 50% (Class F7) is to be placed upstream of the nozzle system.

Air velocity

0.9...2.8 m/s (ideal conditions)

If the air velocity is outside this range please contact HygroMatik.

Pressure drop

Pressure drop is approx. 80 Pa (with an air velocity of 2.0 m/s in a setting of one Vortex module wall and two dry aerosol separators).

9. Electrical connection

⚠ WARNING

Danger of electrical shock!

Dangerous electrical voltage!
All work relating to the electrical installation may only be carried out by designated specialist personnel (electrician or qualified person with equivalent training).

Please note

The customer is responsible for monitoring the qualifications of the specialist personnel.

Do not connect the high-pressure nozzle system to the live power supply before all installation work has been completed.

General installation rules

- All local rules concerning the implementation of electrical installations must be obeyed
- Electric connector cables to be laid professionally
- Install the electrical connections according to the wiring diagram
- Electrical connection to a permanent line is mandatory (according to VDE 0700 Part 98, IEC 60335-2-98) with circuit breaker ratings as required by the technical specifications of the unit
- Ensure that all terminal screws are securely fastened

NOTICE

Possible electronical components destruction through electrostatical discharge!

Prior to commencing electrical installation work, steps (e.g. ESD protection) must be taken to guard the sensitive electronical components of the unit control against damage from electrostatical discharge.

9.1 Electrical installation approach

⚠ WARNING

Danger of electrical shock due to remanence voltage!

The frequency converter terminals can show hazardous voltages for some time even after switching off.

Before touching the terminals wait **at least 180 secs.**

Since leakage currents > 35 mA may occur, a second PE conductor must be connected to the second PE terminal. Use

- 2.5 mm² wiring in the case of protected installation
- 4.0 mm² for unprotected installation

Please note

If a residual current device is to be installed upstream of the system a universal-current-sensitive circuit-breaker should be selected.

9.2 Main connection

Main connection: 1/N/PE_AC_230V, 50 Hz

Pump group	Rated power [kW]	Rated current [A]	Fusing [A]
HPS250	1,48	6,45	B16
HPS500	2,4	10,4	B16

Please note

When sizing the connection lines, observe that the supply impedance must be low! If a short circuit occurs the circuit-breaker must switch off automatically within 0.4 s. The magnetic short circuit trigger for the circuit-breaker (type B) responds immediately when the flowing short circuit current is more than five times the rated current.

9.3 Safety (interlock) system

Across terminals 1 and 2 of terminal block X1, the so called safety interlock system is attached. The safety interlock systems allows for the wiring in of safety devices. With an open safety interlock, the high-pressure nozzle system does not commence or ceases operation.

Integration of a max. hygostat into the safety interlock is state-of-the-art. The max. hygostat serves as a safety element in case of malfunction of the humidity sensor and protects against over-humidification. Further interlock contacts, such as from air flow relays, duct pressure switches, ventilator interlocks etc., are to be serially wired into the safety interlock system across terminals 1 and 2 of X1.

Please note

The contacts across terminals 1 and 2 of X1 must be potential-free and suitable for 230 VAC switching.

⚠ WARNING

After commissioning the high-pressure nozzle system, a voltage of 230 VAC is present on terminal 1 of ST1.1 on the expansion board (wired to terminal 1 of the terminal block X1).

NOTICE

If the ventilation system fails or the supply air face velocity is too low (less than 0.9 m/s) the site monitoring must switch off the high-pressure nozzle system via the safety chain. Otherwise undesired condensate build-up behind the aerosol separator may occur.

9.4 Inspecting the electrical installation

The electrical installation must be checked by an electrician in accordance with customer requirements and the regulations set out by the public electricity supply company:

- Does the mains voltage match the voltage specified on the nameplate / delivery note?
- Have all electrical connections been carried out according to the connection diagrams?
- Have all electrical screw and plug cable connectors been attached properly?
- Are the switch-off conditions for protection in case of faults complied with?
- Has the system been earthed?

The system can then be switched on.

10. Commissioning

The description following hereafter is a short instruction for the commissioning of the high-pressure nozzle system.

In this form, it is primarily ment for recommissioning after decommissioning of the system. For **initial start-up** of the unit by the company in charge for the installation of the nozzle system, a much more detailed document is available with the title „Installation and initial operation instructions for HygroMatik adiabatic humidification systems“.

⚠ WARNING

Improper installation hazard!

Start-up of the high-pressure nozzle system is restricted to HygroMatik staff or authorized personnel only.

⚠ WARNING

Risk of electrical shock!

Hazardous electrical voltage!
Follow safety instructions for work on live components.

Commissioning steps

Prior to **Initial start-up**, the prerequisites required on-site must be met. Pls., confirm by the notification of readiness form attached at the end of the section (sent by fax or e-mail) that this is the case.

Step 1: Check wiring and hose connections

- » Check that all electrical wire connections are tight and secure.
- » Check hose connections for secure clamping and safe connections.

Step 2: Switch-on the high-pressure nozzle system

- » Switch on main breaker.
- » Open water supply stop cock.
- » Switch on unit by setting control switch to “I”.
- » close safety (interlock) system

Step 3: The unit performs a self-test and, then, commences normal operation

- During self-test, the On/Off button icon  flashes for a couple of seconds
- On completion of the test, the commissioning screen is shown in the display for the basic unit settings (such as language, time and date, type of control signal and type of control). On this screen the respective settings must be made except when the settings have been made ex factory according to the order options (for parameter setting, s. section 12.2 „Screen 1 - Initial operation“ in the „Operation of control“ chapter).
- Consequently, normal operation is commenced. However, humidification or cooling is not started without a demand pending

Step 4: Trigger demand

- » Set control to 1-step operation, i.e. permanent demand in the corresponding parameter in the display.
- » Close safety (interlock) system.
- » Place bridge or switch between terminals 3 and 5 (main board).
- The high-pressure pump starts operation and transfers water to the nozzles with a pressure of up to 75 bar.
- Water is atomized by the nozzles.

Step 5: Monitor unit function and check for leakage

- » Let the high-pressure nozzle system operate for about 30 minutes with the duct ventilator running for humidity transport.
- » If leaks appear, switch off the unit.

Step 6: Repair leaks and correct improper spray image

- » Re-work hosing and distribution tube connections, if required.
- » When nozzles drip, check presence and correct seating of o-rings.
- » When spray image is unsatisfactory, clean nozzles in ultrasonic bath as described in the maintenance section.
- » Repeat actions until everything is o.k..

Step 7: All electrical functions must be executable

- » Run through menus and verify system control functions

End of Commissioning.

11. Description of control

11.1 General description

The control is integrated into the high-pressure system housing and is operated via a 3.5" graphic display (touch-screen) on the front side of the unit.

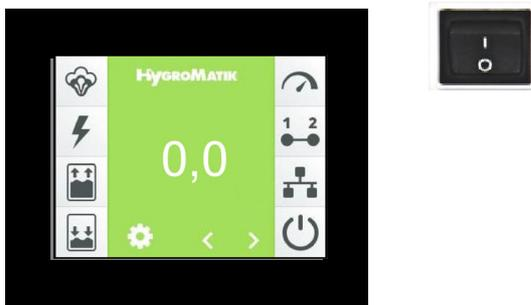

Touchscreen and main switch

The only other operating element is the main switch whose positions are assigned as follows:

Pos. "0": The unit is switched off

Pos. "I": The unit is switched on and the control is active

By changing the parameters, the operator can adapt the control to the system specifications and the special characteristics relating to the use of the unit.

Operation of the control is described in detail in section 12.

11.2 Layout of control

The control consists of the 3,5" display, the mainboard and an expansion board that is attached to the mainboard. The mainboard can be expanded for additional functions with additional optional relays in DIN rail format.

The DIN rail relays are connected via cables with plug. Up to 2 additional relay modules can be used, with 2 relays each.

The external circuitry for the control voltage and the interlock (safety) system (wired to the X1 terminal block) are fed to the control electronics via plug ST1.1 of the expansion board

and are looped from there to the mainboard. Fusing of the control voltage is made on the mainboard by 2 2.5 A fast-blow fuses (F1, F2).

The low voltage supply power für expansion board is channeled from the mainboard to the expansion board through plugs ST11.1 and ST08. This connection is also used for the bidirectional serial data exchange between the logic modules on the two boards.

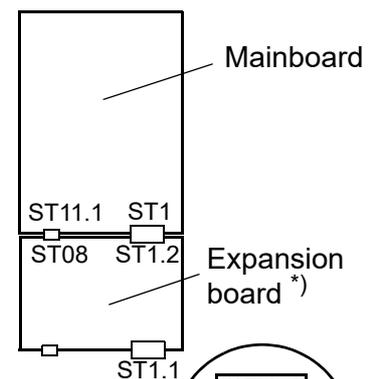

Connections

(via terminal block X1):

L,N: 230 VAC control voltage
1,2: Interlock (safety) system

*) The expansion board is referred to as „Cylinder expansion“ in other sections of this manual due to internal reasons.

11.3 Mainboard

The mainboard is "the heart" of the control. All logic functions and control operations for the high-pressure nozzle system are provided here. For driving the main contactor, the flushing solenoid valve and the 2nd-load solenoid valve, three relays are located directly on the mainboard. A fourth relay, the „basic relay“, can be programmed for signalling and switching tasks. For additional functions, the optional available relays on the plugs ST10.1 and ST10.2 can be used.

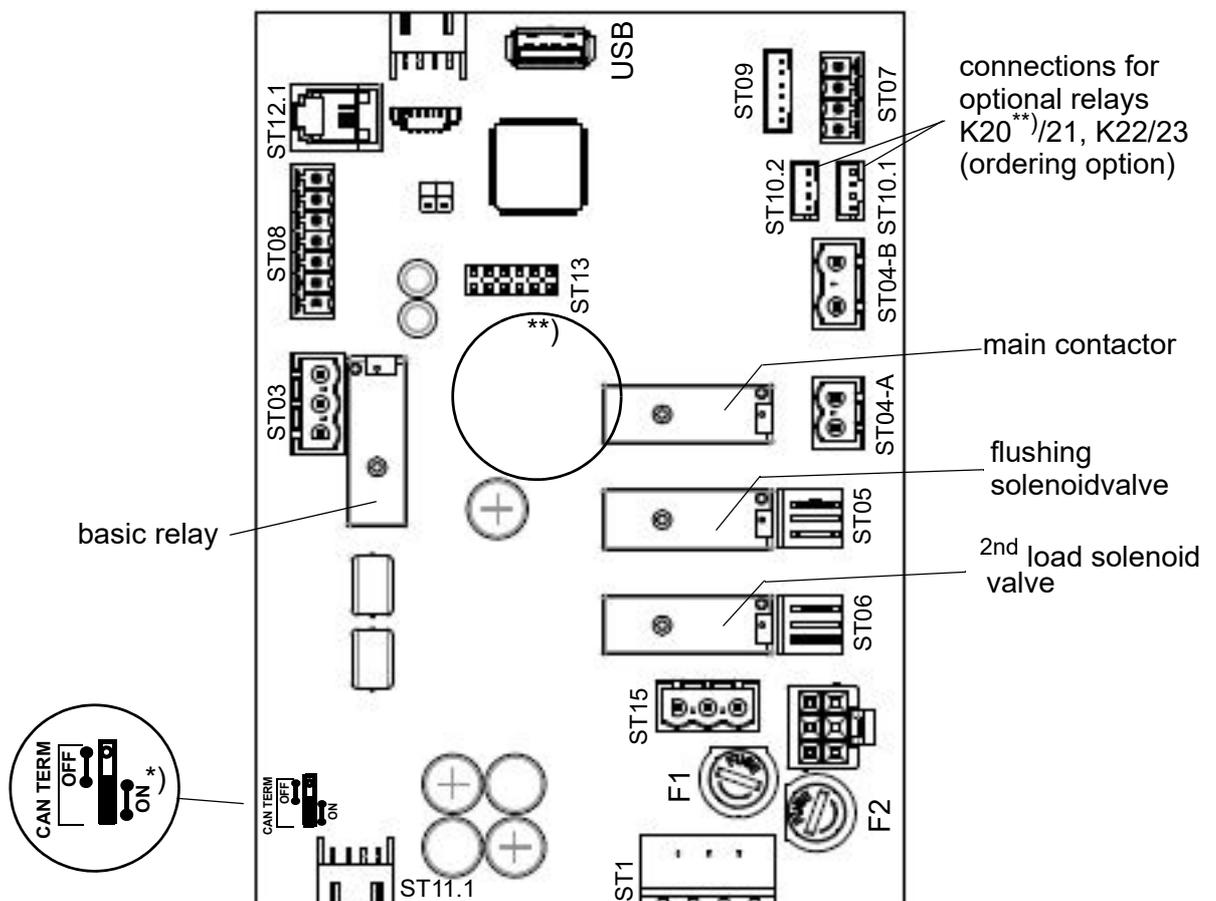

*) This jumper must always be set to „ON“

**) K20 is built-in ex factory for the switching of the 4th load exhaust air cooling in case of 4-load and combined systems

Ex-factory relay assignment:

In case of a unit without any additional options built in, assignment of the base relay (ST03) is „Collective fault“. All other relay contacts carry the assignment „Not in use“.

11.3.1 Connections on the main-board

11.3.1.1 Customer-side interfaces

Inputs

ST08:

- 05: control signal input 0...10 VDC
- 06: control signal input 0...20 mA
- 07: control signal input 0...140 Ω
- 08: digital input „Start cooling“ (12 VDC)

Outputs

ST03:

- Potentialfree NC and NO contacts of the basic relay. Ex-factory assignment of the basic relay is „collective fault“. The assignment can be changed to an other signalling or switching function by programming the relevant parameter

ST10.1/ST10.2:

- Connections for a pair of optionally orderable relays K20/K21 (ST10.1) and K22/K23 (ST10.2) each in DIN rail version with wiring harness, usually freely assignable. When a 4-load or a combined system was ordered, K20 and K21 are part of the delivery. K20 is then used in exhaust air cooling mode for the control of the „cooling“ valve, in the supply air humidification mode for switching of the 4th load. K21 is freely assignable. In units with a switched bypass valve, the valve is controlled by relay K21.

ST07:

- Control output for driving the frequency converter (0...10 VDC)

ST08:

- 03: +20 VDC supply (max. 20 mA)

USB:

- Connection for USB stick for use as a data logger and for parameter or software updates

11.3.1.2 System-side interfaces

ST1:

- 4-pin plug connection for the connection of L1 and N and the interlock (safety) system, looped via ST1.2 of the expansion board

ST11.1:

- +12 V, GND, CAN-Bus

Inputs

ST09:

- (0-I): plug monitoring (12 VDC)
- (14): temperature 50 °C (5 VDC)
- (16): pump temperature (5 VDC)

ST04-B:

- Pressure switch in water inlet

Outputs

ST04-A:

- 9/NMain contactor (230 VAC)

ST05:

- 10/N: Flush valve (230 VAC)

ST06:

- 11/N: 2nd load

ST10.1:

- 20/C: Relay K20 connection for 4th load in case of supply air humidification or exhaust cooling in case of combined systems

Bi-directional

ST12.1:

- Serial interface for touch screen connection

•

ST 13:

- Base for adapter board with RS485 interface

11.4 Expansion board

The expansion board provides - besides further inputs - additional relays for the switching of the water intake solenoid valve and the 3rd load (the 1st load is selected by default when humidification starts, the 2nd load is switched on the main board). In case of a combined system, only 3 loads can be switched. The relay contacts on „ST04“ are then used for switching the supply air humidification - in the 1st load.

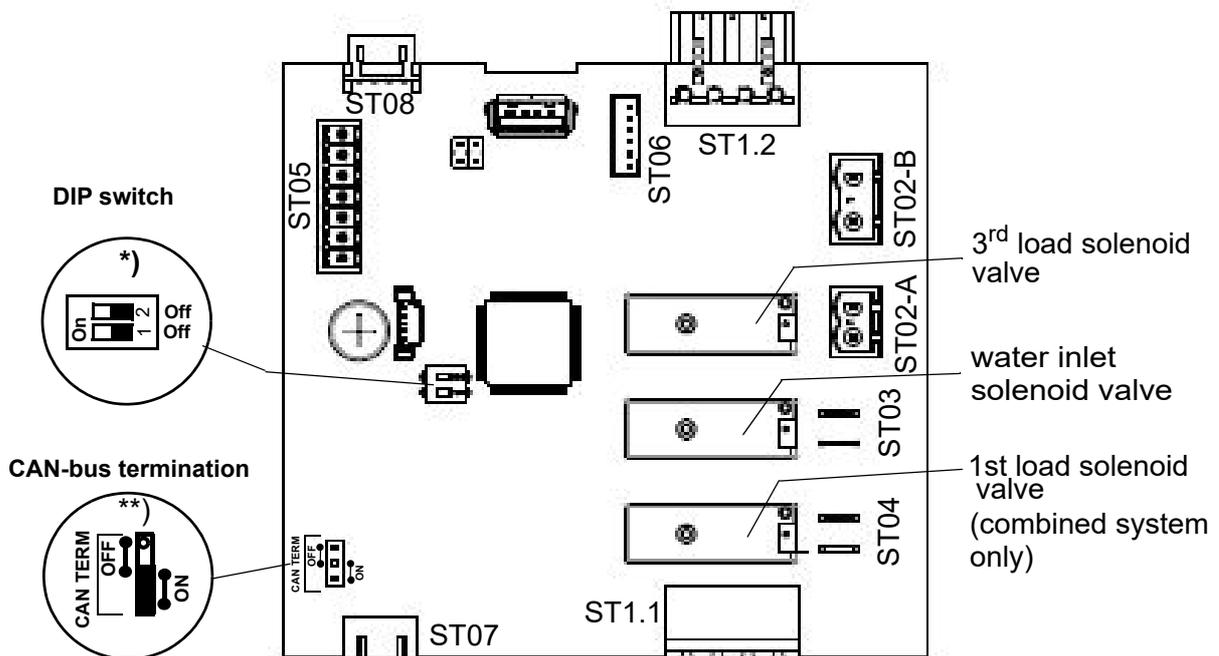

*) The DIP switches serve for CAN-bus address setting. They are factory preset according to the unit configuration. When replacing an expansion board, ensure the identical setting is made as it was before.

**) The jumper for the CAN-bus termination is in the „ON“ position only on the lowest pc board of the assembly. The termination is then effective. On the expansion boards that may be attached in higher mounting positions, the correct jumper setting is „OFF“ (in a standard configuration, only one expansion board is present, the jumper of which then must be set to the „ON“ position).

11.4.1 Connections of the expansion board

Inputs

ST05:

- 06: high pressure sensor (0...20 mA)
- 08: digital input for switching between humidification/cooling (12 VDC)

ST1.1:

- 4-pin screw / plug connection for the connection of L1 and N and the inter-lock (safety) system

ST1.2:

- Loop-through of ST1.1 for on-passing to ST1 of the mainboard

ST07:

- +12 V, GND, CAN-Bus

ST08:

- Loop-through of ST07

Inputs

ST02-B

- Pump motor temperature (230 VAC)

ST06:

- 0-I: plug monitoring (12 VDC)
- 14: fault frequency converter (5 VDC)
- 16: leakage

Outputs

ST02-A:

- 9/N: 3rd load (230 VAC)

ST03:

- 10/: water intake solenoid valve (230 VAC)

ST04:

- 11/N: 1st load (230 VAC), only with combined system

11.5 Connection terminals block

Depending on the particular implementation, the connections in question may also be made via the central terminal block X1.

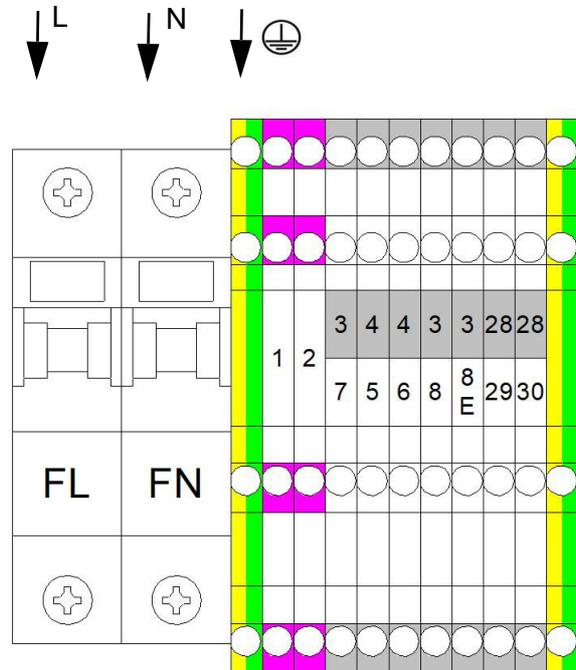

- Power supply 230V/50Hz at X1:FL und X2:FN
- Potential-free contact for release at X1:1 and X1:2
- Up to 4 freely programmable relays K20-23
- 1-step X1:3/5
- 0-10V X1:4/5
- 0-20mA X1:4/6
- 0-140 Ohm X1:4/7
- If active sensors are used, X1:3 serves as power supply 20VDC (max. 30mA)
- Switching between humidifying and cooling X1:3/8E
- Start cooling X1:3/8
- Basic relay (free configurable) X1:28/29/30

11.6 Electrical connection

▲WARNING

Danger of electric shock!

Dangerous electric voltage!

All work relating to the electrical installation may only be carried out by designated specialist personnel (electrician or qualified person with equivalent training).

Please note

The customer is responsible for monitoring the qualifications of the specialist personnel.

NOTICE

Potential component damage due to electrostatic discharge!

To protect the sensitive electronic components, measures to prevent damage due to electrostatic discharge must be taken before the start of the installation work.

11.6.1 Connection of control voltage

The control voltage of 230 VAC is to be applied to terminal block X1 and, from there, is fed to the expansion board (plug ST1.1). Depending on the unit configuration, the terminal block X1 terminals for control voltage connection are labeled „FL“ and „FN“ in case of additional fusing implemented.

11.6.2 Connection of interlock (safety) system

The so-called interlock (safety) system is located between terminals 1 and 2 of the X1 terminal block. Safety equipment can be wired (also in series) into the interlock (safety) system. If the interlock (safety) system is open, the high-pressure nozzle system does not start or the operation is interrupted.

In air conditioning, it is standard to incorporate a max. hygostat in the interlock (safety) system. The max. hygostat is used as a safety feature in case of a malfunction of the humidity sensor.

▲WARNING

Danger of electric shock!

Dangerous electric voltage!

After the initial operation of the unit, a 230 VAC voltage is present at terminal 1 of ST1.1 (expansion board).

Safety (interlock) system

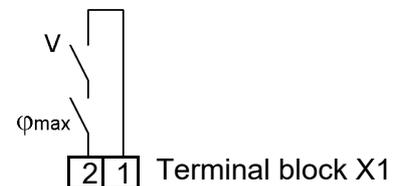

Terminals 1/2 wiring on terminal block X1 for connection of the safety (interlock) system

Please note

The interlock (safety) system is not closed when delivered ex-factory!

Please note

The contacts, which are connected to terminals 1 and 2 of terminal block X1 must be potential free and suitable for switching of 230 VAC.

11.6.3 Terminal wiring for the various modes of operation

Standard operating mode of the high-pressure nozzle system is „supply air humidification“. Optionally, a „combined unit“ that supports both modes of operation in a switchable form may be ordered (for further information concerning the various modes of operation, see section 4). Each of the operational modes requires a particular terminal wiring that is shown in the figs. below. Any switching contacts (to be supplied by the customer) need only be low-voltage proof. If the system is modified on the customer site, the digital inputs on the main board and possibly on the extension board must be parametrized accordingly (s. section 13). The parameters in question are indicated in context of the respective terminal wiring depicted hereunder. Depending on the particular implementation, the connections in question may also be made via the central terminal block X1.

11.6.3.1 Terminal wiring for supply air humidification (standard delivery)

1-step operation

Terminal strip on ST08



Terminal 3/5 wiring on the mainboard (terminal strip on ST08) for 1-step operation

Operation with active humidity sensor or external controller

When driving the high-pressure nozzle system with an active humidity sensor or through an external controller (e.g. a PLC), physical control signals in the range of 0...10 V, 0...20 mA or 0...140 Ω can be used. For each of the signal variants a particular terminal is provided on the mainboard. In all cases, reference potential is terminal 4, „GND“.

If an external control signal 0...10 V is used, wiring is to be made to terminal 4 (GND) and 5 (signal) . Wiring for a resistive signal 0...140 Ω is across terminals 4 and 7. A humidity sensor with current output 0...20 mA is to be wired across terminals 4 (GND) and 6.

Wiring variants (exemplary):

Terminal strip on ST08

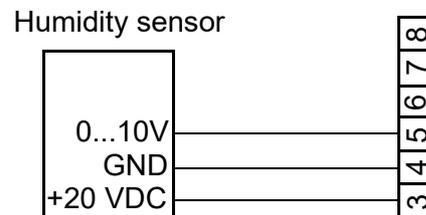

Terminal 3/4/5 wiring on the mainboard (terminal strip on ST08) for connection of a humidity sensor 0...10 V

Please note

Active humidity sensors require an external supply voltage. Terminal 3 provides +20 VDC for that purpose.

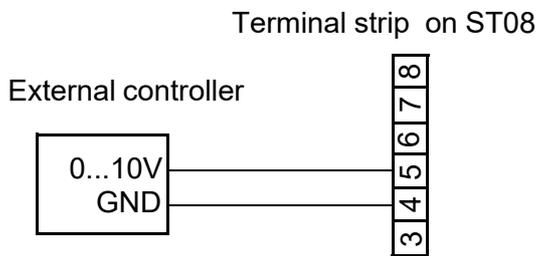

Terminal 4/5 wiring on the mainboard (terminal strip on ST08) for connection of a 0...10V external control signal

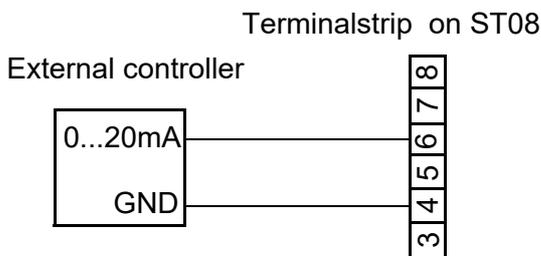

Terminal 4/6 wiring on mainboard (terminal strip on ST08) for connection of an external control signal 0...20mA

11.6.3.2 Terminal wiring for a combined unit (ordering option)

A combined unit allows for the alternative operation of supply air humidification and exhaust air cooling. The supply air humidification mode supports all available control variants while the exhaust air cooling is always run in 1-step mode. Switch-over between the two alternative operational modes is accomplished by switch S3 on the terminal strip on ST05 of the expansion board. For the exhaust air cooling to become effective, switch S2 must additionally be closed. Switch S1 is not functional in exhaust air cooling mode. It is used for activating 1-step operation (S1 closed) in supply air humidification mode.

Supply air humidification/exhaust air cooling switch-over

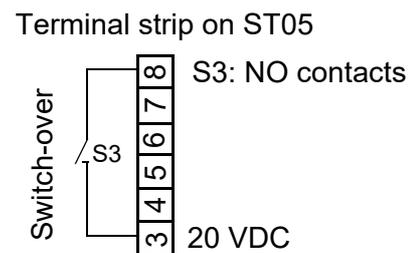

Terminal 3/8 wiring on the expansion board for switching-over between supply air humidification (S3 open) and exhaust air cooling (S3 closed), making use of digital input

The parameter „Digital_input_function“ (17:cylinder extension/1) must be set to „50“.

Switch-on of exhaust air cooling

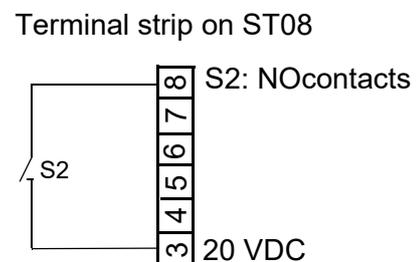

Terminal 3/8 wiring on the mainboard (terminal strip on ST08) für for switch-on of exhaust air cooling (S2 closed). In order for S2 to become effective, S3 on ST05 must be closed.

Additionally, the parameter „Cooling“ (15:adiabate/12) must be set to „1“ (only visible when code „090“ was input).

Parameter „Digital_input_function“ (10:functions/12) must be set to „51“ in order to allow the start of the exhaust air cooling.

Switch for 1-step operation in supply air humidification mode

Terminal strip on ST08

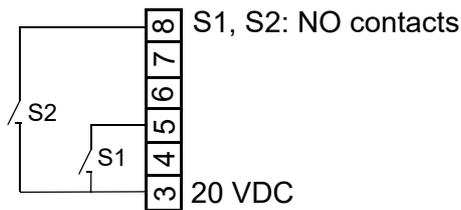

Terminal 3/5/8 wiring on the mainboard (terminal strip on ST08) for exhaust air cooling (S2 open). The one-step operation will be switched on by closing S1.

11.6.4 General use of the digital input on the mainboard

The digital input on the main board can be used for switching functions, unless it has already been configured in ex-works. The digital input must be wired on-site in accordance with its use, e.g. with a switch (also see section 13 „Function parameters“).

Terminal strip on ST08

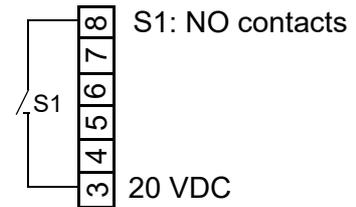

Terminal 3/8 wiring on mainboard (making use of the digital input)

Operation with active humidity sensor or external controller

Terminal wiring of the mainboard is to be made as for the standard unit (supply air humidification ex-factory), exemplarily shown below for the connection of an active humidity sensor. Additionally, the terminals on ST05 of the expansion board must be wired with S3 for switch-over.

Terminal strip on ST08

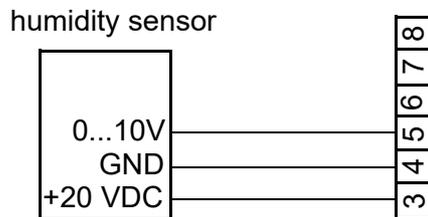

Terminal 3/4/5 wiring on the mainboard (terminal strip on ST08) for connection of a 0...10 V active humidity sensor

12. Screen

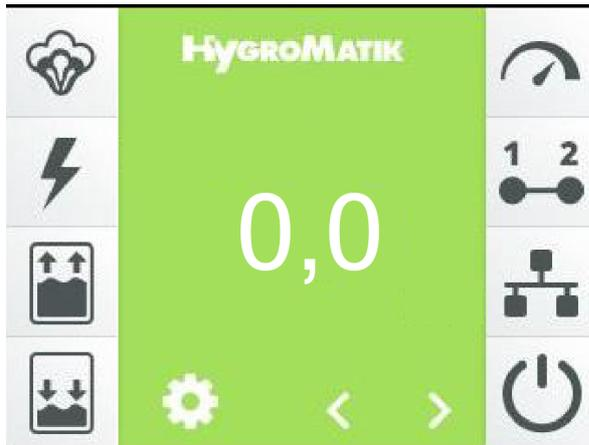

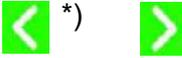
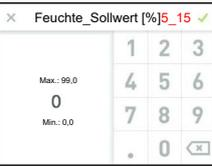
Active screen area	Use
	Main display for operating values, navigation using the scroll keys ^{*)} .
	Scroll keys can be used to display the following operating values: <ul style="list-style-type: none"> • Pressure_actual_value [bar] • Pressure_set_value [bar] • Frequency_set_value [Hz] • Humidity_actual_value [%] • Humidity_set_value [%] ¹⁾ touching it opens a screen keyboard ^{**)} that allows for changing the set value • Demand [%] • Control_signal_internal [%] • Humidity_actual_value_max^{1),2)} • Humidity_set_value_max^{1),2)} ¹⁾ only when „PI controller“ is set ²⁾ only when „Floating max. limiter“ is set
	Screen keyboard for changing the humidity set value; is displayed when the humidity set value display is touched; allows direct changing of the set value. Saving of the input by touching the confirmation tick in the upper right corner, exit without saving by touching the „X“ in the upper left corner.
	Button to call up set-up mode (via password). Password „000“ -> Basic level (see Section 12.5) Password „010“ -> Advanved level (see Section 12.7)

Active screen area	Use
  	<p>In the event of a fault or a service message, the relevant display field is shown instead of the HygroMatik logo. Touching it opens the unit info screen (see Section 5.9).</p>
	<p>Unit info screen (see Section 5.9) for the display of error and service messages in plain text. Is displayed by touching the error or service message.</p>

Icon	Status	Meaning
	dark bright flashes	Humidification/cooling active No humidification/cooling Fault (code of fault is shown in the fault display field)
	dark bright flashes	Main contactor switched Main contactor not switched Fault main contactor
	dark bright flashes	Water inlet active Water inlet not active Fault water inlet
	dark bright flashes	Water outlet active Water outlet not active Fault water outlet
	dark bright flashes	Demand has been made Demand has been made Fault demand
	dark bright	Interlock (safety) system closed Interlock (safety) system open
	dark bright	Virtual interlock (safety) system closed (via communication interface) Virtual interlock (safety) system open
	dark bright flashes	Operating mode display No humidity control enabling due to e.g. open safety interlock (details can be found in Read_values/Status_unit). Unit is in the initialisation phase

13. Operation of control

13.1 Operation basics

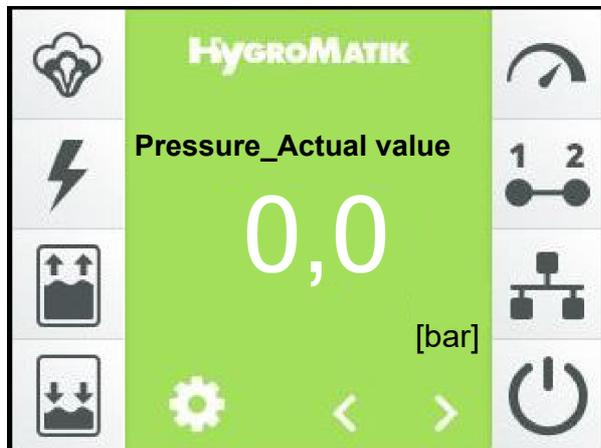

Operation takes place via the built-in touch-sensitive 3.5 inch screen. It is used for all operating steps required for the settings and operation of the unit. In addition to operating the unit directly, it is possible to control it remotely via the building technology control system or a PLC, using the communication interface. Supplementary documentation is available from HygroMatik for this type of application.

Screen views

The operating structure uses several screens, which are schematically displayed in the table below.

User guidance

In the user guidance, a distinction is made between the "basic level" and "advanced level". While the basic level only makes it possible to carry out basic device operations, the advanced level also permits operating parameters to be changed. The 2nd table below clarifies this again. The possible operating functions of the two levels are presented in Sections 12.5 and 12.7.

Naming convention for parameter references

When a parameter is referenced to in the sections following hereafter, this form is used:

xx:name/yy,zz with

xx = parameter group (numerical)

name = designation of group/submenu/
screen view

yy = no. of parameter in list

zz = setting or reading value

Overview of the screens

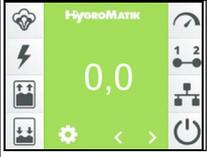
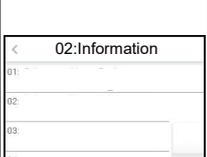
	Content of screen page	Presentation	Sec.
Screen 1 Commissioning	Used for the basic unit settings (e.g. user language) after the unit is switched on for the first time. This page is then closed. To do so, use the confirmation tick to exit it.		12.2
Screen 2 Main screen	Displays the current operating values and unit status information (status icons).		12.3
Screen 3 Main menu (basic level)	Allows access to submenus for limited unit settings, read values and history .		12.5
Screen 3 Main menu (advanced level)	Allows access to submenus for comprehensive unit settings, read values, parameter settings, service settings and history.		12.7
Screen 4 Unit information	Is only displayed after a fault or a service message has occurred; provides information on device data, statistics, faults that have occurred and service requirements.		12.9

Operating ranges at the user/operator level

Level	Permits
Basic level	<ul style="list-style-type: none"> • Display of the read values of the main screen • Setting the humidity set value in the main screen • Display of the unit information after a fault or status message • After entering the password - call-up and cancellation: Display of the complete list of read values and adjustment options for some service parameters
Advanced level	<ul style="list-style-type: none"> • All functions of the basic level • Advanced settings options for operation and service parameters

13.2 Screen 1 - Commissioning

After connection to the mains supply and initial actuation of the control switch, the commissioning screen for the basic device settings appears on the display once the self-test of the control has been completed:

X	01: Commissioning	✓
01: Language	<i>English</i>	
02: Date	<i>31/10.2020</i>	
03: Time	<i>11:59</i>	
04: Control	<i>User-defined</i>	

13.2.1 Setting the language

- » Touch the line with parameter "01: Language". The following screen is displayed:

<	Language	✓
<i>German</i>	✓	
English		
<i>Francais</i>		
<i>Castellano</i>		∨

The currently selected language is marked with a tick in the relevant line. With the scroll-down button, the 2nd page of the screen is displayed if required.

- » Change the language by touching it, if required

- » Confirm the input and return to the "Initial operation" screen with the green tick in the top right (cancel by touching "X").

13.2.2 Input of date and time

The parameter "02: Date" and "03: Time" require digits to be entered. To do so, a screen with a keyboard and an input field in the date or time format will be displayed after touching the relevant line.

As an example, the date input is described below:

- » Touch line "02: Date". The following screen is displayed:

X	Datum			✓
28.10.20				
	1	2	3	
	4	5	6	
	7	8	9	
	.	0	⌫	

- » Enter the date in the format DD.MM.YY (D = day, M = month, Y= year) as digits only (the dots are added automatically)
- » Confirm the input and return to the "Initial operation" screen with the green tick in the top right (cancel by touching "X")

13.2.3 Control settings

The type of unit control is specified in the next step. The screen offers the most commonly used combinations of the operating mode of the control (1 step, controlled with an external regulator, with the internal PI controller, via the communication interface, slave operation), the type of control signal (voltage, current or resistance signal) and the control signal range (e.g. 0... 10 V). If these values have already been factory-preset according to customer requirements, the selection tick appears in the "User-defined" line.

The parameters are displayed in blocks on a screen page, which include a maximum of 4 entries. Scroll keys are used to switch between the individual screen blocks.

The initial operation is now complete. If the initial operation screen was exited with the confirmation tick, the main screen is automatically shown in the display.

The initial operation screen is no longer displayed in future. Future changes with respect to the parameters set during initial operation must be made on operator level in sub-menus „Settings“ and „Control“.

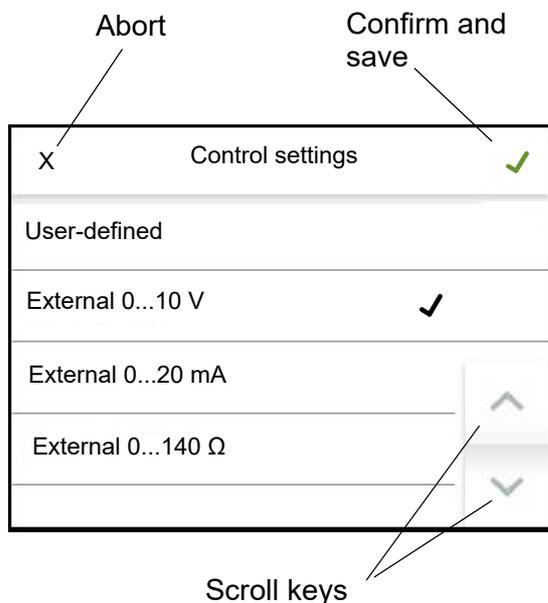

- » Confirm the input and return to the "Initial operation" screen with the green tick in the top right (cancel by touching "X")
- » Pressing the green tick in the top right saves the entries and exits the initial operation screen (cancel by pressing the "X")

13.2.4 Line-up of the commissioning parameters

01: Commissioning

No.	Parameter	No.	Adjustment/value range			Meaning/Comment
			Factory setting (FS)	Min	Max	
1	Language		Selection			Selection of language
		0	Deutsch			Deutsch
		1	English			Englisch
		2	Francais			Französisch
		3	Castellano			Spanisch
		5	Italiano			Italienisch
		6	Русский			Russisch
		7	Svensk			Schwedisch
2	Date			DD.MM.YY		Set date
3	Time_of_day			HH:MM		Set time
4	Control_settings		Selection			Combinations of control type and input signal type/range
		0	User_specified			The selection was carried out separately during initial operation according to control type, signal type and area. This is a read value only
		1	Extern_0...10 V			External controller [73] with voltage signal 0... 10 V
		2	Extern_0...20 mA			External control [73] with current signal 0...20 mA
		3	Extern_0...140 Ω			External controller [73] with ohmic signal 0...140 Ω
		4	PI-controller_0...10 V			Internal PI controller [96], controls with voltage signal 0...10 V
		5	PI-controller_4...20 mA			Internal PI controller [96], controls with current signal 4... 20 mA
		6	PI-controller_0...140 Ω			Internal PI controller [96], controls with ohmic signal 0...140 Ω
		7	1-step			1 step operation [44]
		8	Modbus			Control via software control commands [12] through communication interface [13]
		11	Pi-controller_V_max_mA			Selection of current input on the mainboard for the 2nd PI controller when using the floating max. limiter [35]
		21	Extern_V_Max_mA			
5	Recording		Selection			Recording [93] of parameter sets
		0	Deactivated			No recording
		1	Activated			Start recording

13.3 Screen 2 - Main screen

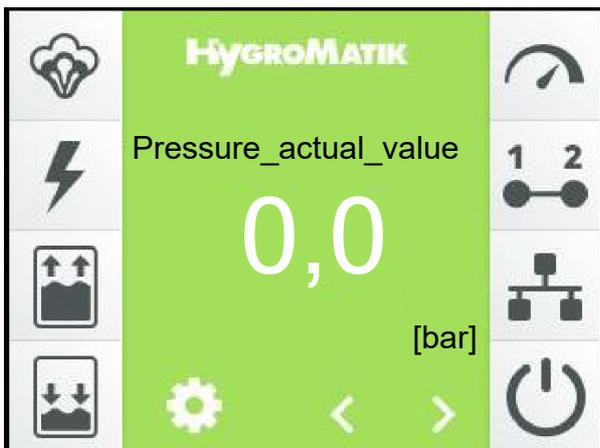

The values for the normal display brightness and the dimmed state can be adjusted by the user, as well as the duration after which the main screen is changed to the dimmed state (s. section 12.6.1).

The main menu of the basic level and the advanced level (screen 3) is accessed by touching the  icon.

The main screen is shown in the display after the unit is switched on, unless the unit is being switched on for initial operation (see Section "Commisioning"). In the main screen, current operating values are represented as numerical information, as well as status information in the form of icons. The display elements were described in Section 12 "The screen". A flashing icon always indicates a fault.

The left row of icons refers to the operational conditions of the unit. The right row of icons indicates the status of releases. For steam production to take place, all icons on the right side of the screen must be active.

The scroll keys  and  allow the user to move through the list of display values on the main screen (see Section 11, "The screen"). With the exception of the target humidity, these are read values only. The displayed values are shown and explained in the table in the following section.

If an error has occurred or a service message is issued, a display field with the relevant message is displayed instead of the Hygro-Matik logo. The user can access the unit info screen by touching this field.

The brightness of the main screen is reduced after a certain time (screen brightness is dimmed). The two scroll keys and the settings icon are also hidden at this point. The original state is restored by touching the screen.

Table of the read values available in the main screen and the humidity set value (only when PI-controller was selected)

Mainscreen

No.	Parameter	No.	Adjustment/value range			Meaning/Comment [] explains the term in the glossary → [] refers to a related explanation of the term	
			Factory setting (FS)	Min	Max		FS
	Pressure_acutal_value					Read value	The current system pressure in the unit in bar
	Pressure_set_value					Read value	The set point of the system pressure in bar
	Frequency_set_value					Read value	The frequency set value for the frequency inverter
	Load_actual					Read value	The current load range of the system at the time of reading.
	Humidity_actual_value					Read value	Actual value [1] of rel. humidity [2] in %
	Humidity_set_value		0,0	99,0	50,0		Set value [3] of RH [2] in %
	Demand					Read value	The demand [5] is the control signal from which the internal actuator signal [42] is created
	Control_sig_internal					Read value	Internal actuator signal [42] as a percentage of the actuator signal for the nominal output
	Humidity_actual_max					Read value	Actual value [1] of rel. humidity [2] in % whwn floating max. limiter [35] is activated
	Humidity_set_max		5,0	99,0	80,0		Specification of max. humidity for the switch-off point when using the floating max. limiter [35]

13.3.1 Changing the set point humidity

The set point humidity may only be changed if „PI controller“ was selected as the control mode.

- » Select the "Humidity_set value [%]" screen using  or .
- » Tap on the Humidity_set value display.
- » Enter the value of the intended humidity set value using the on-screen keyboard which has opened.
- » Confirm the input and save using the check mark in the top right, cancel using the "X" in the top left.

13.4 Password entry

The password determines if the main menu of the basic level or the advanced level is displayed. The password codes in use are:

Code 000: The main menu of the basic level becomes accessible. However, it is sufficient to leave the password prompt with the green tick, without explicitly entering the code.

Code 010: The main menu of the advanced level becomes accessible.

The password entry is called up in the main screen by touching the  button. A virtual keyboard is shown on the screen for entering the password:



To open the basic level, it is sufficient to select the X symbol (top left). The advanced level is accessed through the sequential input of the code digits "0", "1" and "0" and confirming them with the green tick (top right).

13.5 Screen 3 - Main menu (basic level)

After selecting the basic level, the icons of the submenus which are available without password entry are displayed:

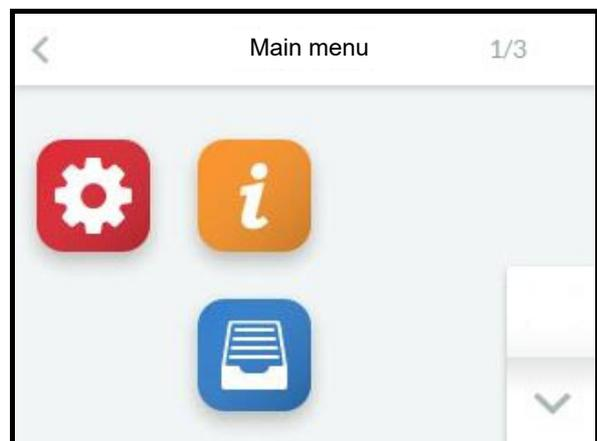

13.6 Basic level submenus

Icon	Selection of submenu
	Settings
	Read values
	History

By tapping on the respective icon, the user accesses the screen page where the parameters of the respective group are displayed for selection, viewing or for making changes.

Layout of screen page

The input fields in which changes can be made are shown in *italics>. Depending on the parameter, the input has to be made by:*

- selection from predefined offers (multiple choice, see example 1)
- entry of numeric values using an on-screen keyboard (see example 2).

Example 1: Selection of user language:

Call up the language selection on the screen by touching "Language:

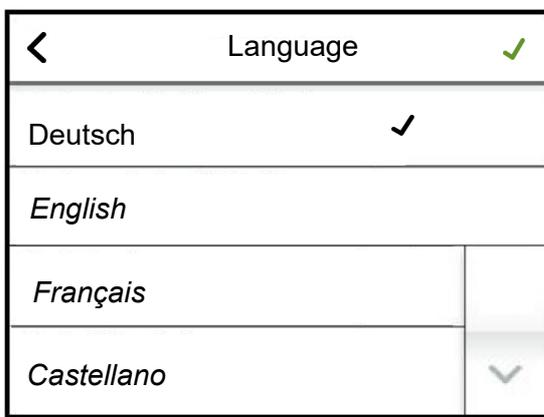

By tapping on the required language, the black tick moves to the corresponding row. By touching the green tick (top right), the selection is saved and the display returns to the parent screen.

If the settings are to remain unchanged, it is possible to return straight away using the < key.

Example 2: Setting the screen brightness

Touch "Screen_brightness normal" on the screen to call up the input mask:

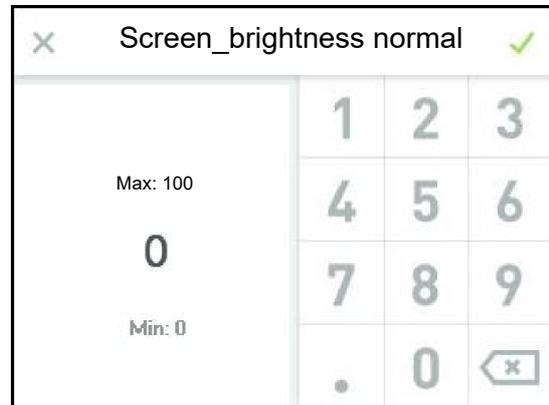

The screen brightness which is set is displayed and can be changed by using the keyboard. Save and return by touching the green tick, leave the input mask without changes by touching the "X".

The screens are hidden after a certain period of time. The main screen is then displayed. The time until the return to the main screen can be set by the user.

If a submenu is to be called up again after a screen has been closed automatically by a time-out, this can only be done through the settings icon in the main screen. This also means that the password has to be re-entered. As long as the user continues their work in the area of the main screen, the existing access remains, i.e. no renewed password entry is required.

13.6.1 Settings submenu



Table of settings parameters (basic level)

03: Settings

No.	Parameter	No.	Adjustment/value range			Meaning/Comment [] explains the term in the glossary →[] refers to a related explanation of the term
			Factory setting (FS)	Min	Max	
1	Language		Selection see: 01-1 Language			Selection of language
2	Date		DD.MM.YY			Set date
3	Time_of_day		HH:MM			Set time
4	Display_lighting_normal		5	100	100	Screen backlight in undimmed state
5	Delay_present_page		0	3600	300	Display duration for a certain screen page before return to the main screen in min
6	Display_lighting_dimmed		0	100	50	Screen brightness for dimmed state
7	Display_dim_after		0	3600	120	Switching of screen brightness of main screen to dimmed value after ... seconds. If an error has occurred or a status message is displayed, the main screen is not dimmed
8	Units		Selection			Selection of system of units
		0	SI			Units are displayed in the format of the SI system of units [8]
		1	Imperial			Units are displayed in the format of the imperial system of units [9]

13.6.2 Read values submenu



Read values table (visible on both the basic and the advanced levels)

04: Read values

No.	Parameter	No.	Adjustment/value range			Meaning/Comment
			Min	Max	FS	
1	Status_unit			Read value		Operating condition of unit Control performs initialisation [10] Unit is ready for humidification, but the safety interlock [11] is open. Unit is ready for humidification, but there is no demand [5]. Humidifying [47] Unit was switched off via a software command [12] for opening the interlock (safety) system [83] via the communication interface [13] Steam production was switched off manually via the on/off button [14] The unit is in cooling mode automatic flushing of the nozzle section(s) for humidification automatic flushing of the nozzle section for cooling The system carries out a hygiene flush because there was no humidification or cooling request for a period of x hours (x is stored as a waiting time in parameter 15/1). The system flushes the feed water pipe to prevent microbial contamination The pressure in the spray system is reduced A flushing process (with line pressure) was triggered manually via the touch screen Automatic flushing of the nozzle train for humidification and cooling A service message has appeared. For detailed specification, see read value 8 for cyl. 1 and read value 9 for cyl. 2 (double cylinder units only) Unit is performing diagnostics [15] The control electronics is not yet programmed for the unit type A USB stick was plugged in and a parameter upgrade is run by the unit A parameter upgrade was successfully carried out. Restart of the unit is required
		0		Initialization		
		1		Safety_interlock_open		
		2		No_Demand		
		3		Humidification		
		5		Remote_off		
		6		No_bus-signal		
		15		Cooling		
		150		Flush_humidification		
		151		Flush_cooling		
		152		Flush_hygiene		
		153		Flush_dead_leg		
		154		Discharge		
		155		Flush_manually		
		156		Flushing_humidification_cooling		
		270		Service_message		
		900		Diagnosis		
		901		Not_programmed		
		902		Update_in_progress		
		903		Restart		
		999		Fault		
4	Fault_message_unit			Read value		List of possible unit fault messages
				see: 02-1 Fault_message_unit		
7	Service_message_unit			Read value		Service message unit
				see: 02-4 Service_message_unit		
17	Demand			Read value		The demand [5] is the control signal from which the internal actuator signal [42] is created
18	Control_sig_internal			Read value		Internal actuator signal [42] as a percentage of the actuator signal for the nominal output
20	Safety_interlock			Read value		Status of the interlock (Safety) system [11] The interlock (safety) system is open The interlock (safety) system is closed
		0		Off		
		1		On		
21	Safety_interlock_virtual			Read value		Status of the virtual interlock (safety) system [86] The interlock (safety) system is open The interlock (safety) system is closed
		0		Off		
		1		On		
28	Model			Read value		Type designation of unit
29	Unit_name			Read value		Unit name [90], can be selected by the customer, if required
30	Serial_number			Read value		Serial_number
31	Date_of_manufacturing			Read value		Date_of_manufacturing
32	Controller_series			Read value		Type of control
33	Software_version			Read value		Software version of control
34	Humidity_set_value			Read value		Set value [3] of rel. humidity [2] in %
35	Humidity_actual_value			Read value		Actual value [1] of rel. humidity [2] in %
50	V_Signal			Read value		Voltage signal measured on terminal ST0505
51	mA_Signal			Read value		Current signal measured on terminal ST0506
52	Ω_Signal			Read value		Resistance signal measured on terminal ST0507
53	Digital_input			Read value		Actual state of the digital input [97] No switching signal Switching signal present
		0		Off		
		1		On		
56	Pressure_acutal_value			Read value		The current system pressure in the unit in bar

Read values continued

57	Pressure_set_value		Read value	The set point of the system pressure in bar
60	Frequency_set_value		Read value	The frequency set value for the frequency inverter
61	Load_actual		Read value	The current load situation in the spray system
		0	Off	The spraying system is not in operation
		1	1st_Load	The spraying system works in single load mode
		2	2_Load	The spraying system works in two-load mode
		3	3_Load	The spraying system works in three-load operation
		4	4_Load	The spraying system operates in four-load mode
		5	Cooling	The spray system works in the operating mode exhaust air cooling.
		10	Switchover_off_pressure_max	The pressure in the spray system is reduced before the humidification is switched off
		11	Discharge_start	The pressure relief is started
		12	Discharge	Pressure relief is underway
		20	Switchover_pressure_max	The pressure in the spraying system is reduced before a load switch is performed
		21	Switchover_waiting	Switching between 2 load ranges takes place only after a waiting time (see param. 15/8) in order to counteract an oscillation tendency
		22	Switchover	The plant system is in the phase of switching between 2 load ranges
		23	Wait_inlet_valve	The spraying system waits for the opening of the water inlet solenoid valve, which may be delayed due to pressure situation
		24	Flush_cooling_check	The system checks whether flushing of the humidification nozzle sections is necessary
		25	Flush_humidification_check	The system checks whether flushing of the cooling nozzle section is necessary
		30	Flush_humidification	The flushing of the humidification nozzle sections is in progress
		31	Flush_cooling	Flushing of the cooling nozzle section is in progress (only for combined systems)
		32	Flush_hygiene	A hygiene flush is underway
		33	Flushing_humidification_cooling	The flushing of the humidification lines and the cooling line is in progress (only for combination systems)
		99	Error_steps	The switching points for load changeover are not set correctly.
62	Solenoid_valve_flush		Read value	Status of the flushing solenoid valve
		0	Off	closed
		1	On	open
63	Solenoid_valve_inlet		Read value	Inlet solenoid valve status
		0	Off	closed
		1	On	open
64	Loadstage 1		Read value	Status of the solenoid valve for switching the first load (at ST04 11)
		0	Off	closed
		1	On	open
65	Loadstage 2		Read value	Status of the solenoid valve for switching the second load (at ST06 11)
		0	Off	closed
		1	On	open
66	Loadstage 3		Read value	Status of the solenoid valve for switching the third load (on ST02-A 9)
		0	Off	closed
		1	On	open
67	Loadstage 4		Read value	Status of the solenoid valve for switching the fourth load (on ST10.1 20)
		0	Off	closed
		1	On	open
68	Cooling		Read value	Status of solenoid valve for switching cooling (at ST10.1 20)
		0	Off	closed
		1	On	open
69	Unit_total_runtime		Read value	The total runtime of the unit since its first connection to the power supply (specified in days/months/years/hours/minutes)

13.6.3 History submenu



This submenu is identical on the basic and the advanced level.

13.6.3.1 Explanation of history management

The control stores 10 sets of error messages on a rolling basis. Once there are 10 records, the oldest record is overwritten by a current entry. An error message set consists of the following entries:

1. Date of error message
2. Contents of error message
3. Frequency of error message
4. Error origin

If an identical error occurs several times in a row, the first entry relating to this error is updated with the date of the most recent occurrence and the frequency is incremented. A new error message set is not recorded.

The situation is different if a particular error occurs multiple times, but not in direct succession. In this case, a new error message set is written for each instance.

The table below shows the layout of the history management.

Table of history layout

07: History

No.	Parameter	No.	Adjustment/value range			Meaning/Comment [] explains the term in the glossary →[] refers to a related explanation of the term
			Factory setting (FS)	Min	Max	
1	1st fault_entry_date			Read value		1. Memory entry: Date/time
2	1st fault_entry_message			Read value		1. Memory entry: Fault message (for explanation see Read values 4 / Fault_message_unit)
3	1st fault_entry_rate		see: 02-1	Fault_message_unit Read value		1. Memory entry: Frequency of occurrence (since initial operation)
4	1st fault entry			Read value		1st memory entry: source of occurrence
		0	-			is not known
		1	Mainboard			is the motherboard
		4	Humidifier			is the humidifier
		20	Cylinder_extension 1			is the expansion board 1
5	2nd fault_entry_date			Read value		2. Memory entry: Date/time
6	2nd fault_entry_message			Read value		2. Memory entry: Error message, see above
7	2nd fault_entry_rate		see: 02-1	Fault_message_unit Read value		2. Memory entry: Frequency of occurrence (since initial operation)
8	2nd fault entry			Read value		2nd memory entry: source of occurrence
9	3rd fault_entry_date		see: 07-4	1st fault entry Read value		3. Memory entry: Date/time
10	3rd fault_entry_message			Read value		3. Memory entry: Error message see above
11	3rd fault_entry_rate		see: 02-1	Fault_message_unit Read value		3. Memory entry: Frequency of occurrence (since initial operation)
12	3rd fault entry			Read value		3rd memory entry: source of occurrence
13	4th fault_entry_date		see: 07-4	1st fault entry Read value		4. Memory entry: Date/time
14	4th fault_entry_message			Read value		4. Memory entry: Error message see above
15	4th fault_entry_rate		see: 02-1	Fault_message_unit Read value		4. Memory entry: Frequency of occurrence (since initial operation)

Table of history layout continued

16	4th fault entry	Read value	4th memory entry: source of occurrence
		see: 07-4 1st fault entry	
17	5th fault_entry_date	Read value	5. Memory entry: Date/time
18	5th fault_entry_message	Read value	5. Memory entry: Error message see above
		see: 02-1 Fault_message_unit	
19	5th fault_entry_rate	Read value	5. Memory entry: Frequency of occurrence (since initial operation)
20	5th fault entry	Read value	5th memory entry: source of occurrence
		see: 07-4 1st fault entry	
21	6th fault_entry_date	Read value	6. Memory entry: Date/time
22	6th fault_entry_message	Read value	6. Memory entry: Error message see above
		see: 02-1 Fault_message_unit	
23	6th fault_entry_rate	Read value	6. Memory entry: Frequency of occurrence (since initial operation)
24	6th fault entry	Read value	6th memory entry: source of occurrence
		see: 07-4 1st fault entry	
25	7th fault_entry_date	Read value	7. Memory entry: Date/time
26	7th fault_entry_message	Read value	7. Memory entry: Error message see above
		see: 02-1 Fault_message_unit	
27	7th fault_entry_rate	Read value	7. Memory entry: Frequency of occurrence (since initial operation)
28	7th fault entry	Read value	7th memory entry: source of occurrence
		see: 07-4 1st fault entry	
29	8th fault_entry_date	Read value	8. Memory entry: Date/time
30	8th fault_entry_message	Read value	8. Memory entry: Error message see above
		see: 02-1 Fault_message_unit	
31	8th fault_entry_rate	Read value	8. Memory entry: Frequency of occurrence (since initial operation)
32	8th fault entry	Read value	8th memory entry: source of occurrence
		see: 07-4 1st fault entry	
33	9th fault_entry_date	Read value	9. Memory entry: Date/time
34	9th fault_entry_message	Read value	9. Memory entry: Error message see above
		see: 02-1 Fault_message_unit	
35	9th fault_entry_rate	Read value	9. Memory entry: Frequency of occurrence (since initial operation)
36	9th fault entry	Read value	9th memory entry: source of occurrence
		see: 07-4 1st fault entry	
37	10th fault_entry_date	Read value	10. Memory entry: Date/time
38	10th fault_entry_message	Read value	10. Memory entry: Error message see above
		see: 02-1 Fault_message_unit	
39	10th fault_entry_rate	Read value	10. Memory entry: Frequency of occurrence (since initial operation)
40	10th fault entry	Read value	10th memory entry: source of occurrence
		see: 07-4 1st fault entry	

13.7 Screen 3 - Main menu (advanced level)

After the advanced level has been selected by entering the corresponding password (code 010), the main menu is displayed. It spans multiple screen pages and scroll keys are used to navigate between them.

Screen page 1 (of 3)

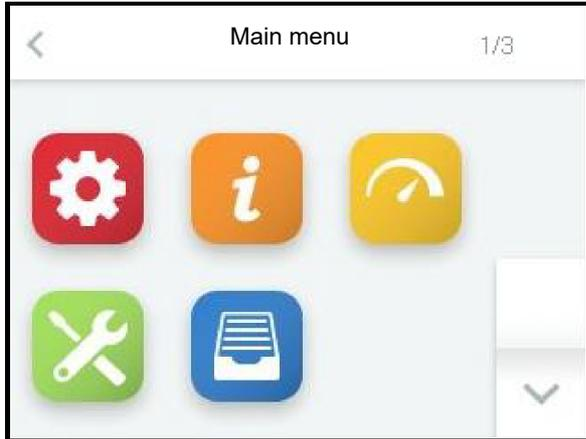

Screen page 2 (of 3)

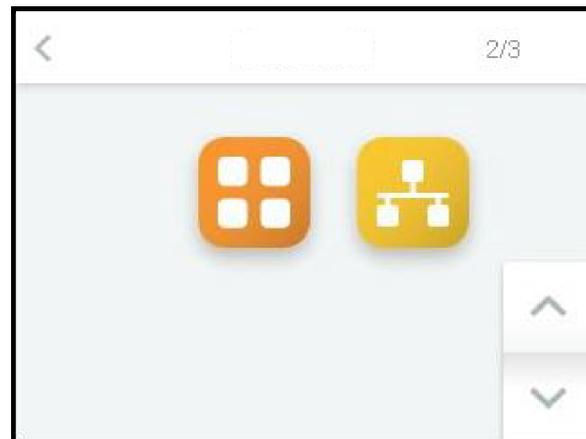

Screen page 3 (of 3)

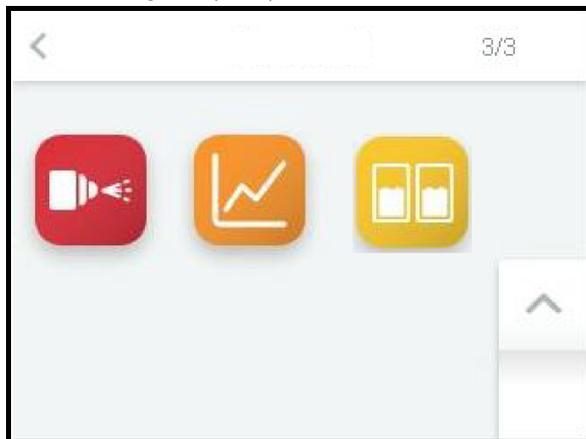

13.8 Advanced level submenus

By touching the respective icon, the operator accesses the screen page where the parameters of the respective group are available for selection, viewing or for making changes. The layout of the screen pages corresponds to the pages of the submenus of the basic level (see Section 13.6).

Icon	
	Settings
	Read values
	Control
	Service
	History
	Functions
	Communication interface
	Adiabate
	Recording
	Cylinder extension ^{*)}

^{*)} Naming of the submenu follows internal reasons only (there is no „cylinder“ built into this device). The submenu serves for the parameterisation of the expansion board that is attached to the mainboard and is used for specific functions.

The parameters available in the submenus are described in table form below.

13.8.1 Settings submenu



Table of settings parameters (advanced level)

03: Settings

No.	Parameter	No.	Adjustment/value range			Meaning/Comment [] explains the term in the glossary →[] refers to a related explanation of the term
			Min	Max	FS	
1	Language		Selection			Selection of language
2	Date		see: 01-1 Language DD.MM.YY			Set date
3	Time_of_day		HH:MM			Set time
4	Display_lighting_normal		5	100	100	Screen backlight in undimmed state
5	Delay_present_page		0	3600	300	Display duration for a certain screen page before return to the main screen in min
6	Display_lighting_dimmed		0	100	50	Screen brightness for dimmed state
7	Display_dim_after		0	3600	120	Switching of screen brightness of main screen to dimmed value after ... seconds. If an error has occurred or a status message is displayed, the main screen is not dimmed
8	Units		Selection			Selection of system of units
		0	SI			Units are displayed in the format of the SI system of units [8]
		1	Imperial			Units are displayed in the format of the imperial system of units [9]

13.8.2 Read values submenu



The read value submenu is no different to that of the basic level. The read values listed in table format in Section 13.6.2 are also available at the operator level.

13.8.3 Control submenu



Table of control parameters

05: Control

No.	Parameter	No.	Adjustment/value range			Meaning/Comment [] explains the term in the glossary →[] refers to a related explanation of the term
			Min	Max	FS	
1	Control_settings		Selection see: 01-4 Control_settings			Combinations of control type and input signal type/range
2	Output_max.		25,0	100,0	100,0	The maximum output power [43] can be limited to between 25 and 100%
3	Δ Power_limitation		0,0	50,0	0,0	Reduction of the max. humidification output for the purpose of load shedding [101].
4	Output_signal		Selection			Mapping of the output signal [69] to an internal value
		0	Off			No mapping
		1	Control_sig_external			Output signal is proportional to the demand [5] from the external controller [73]
		2	Control_sig_internal			Output signal is proportional to the internal actuator signal [42]
		3	Humidity_actual_value			Output signal is proportional to the actual humidity value [1]
17	Humidity_set_value		0,0	99,0	50,0	Set value [3] of RH [2] in %
20	PI-controller_gain		0,5	100,0	5,0	Proportional part of PI controller
21	PI-controller_integral		0	100	10	Integral part of PI controller
22	Humidity_notification		5,0	99,0	50,0	When the set humidity [%] has been reached, one of the relays is energised, which must have been assigned code 211 (humidity reached) for this purpose
23	Humidity_set_max		5,0	99,0	80,0	Specification of max. humidity for the switch-off point when using the floating max. limiter [35]
24	Pi-controller_max_gain		0,5	100,0	5,0	Amplification of 2nd PI controller when using the floating max. limiter [35]
33	Damping_analog inputs		Selection			The attenuation for capacitive sensors is activated. Only possible with activated PI controller
		0	Off			Switch off attenuation
		1	On			Switch on attenuation

13.8.4 Service submenu



13.8.4.1 Service messages

The wear components of the unit are monitored continuously when the unit is in operation. When a limit value is reached, the corresponding service message is displayed. The service messages need to be reset after component replacement or maintenance.

The following **service messages** are implemented:

Operating hours

The parameter „Operating_time_service“ (06:Service/3) holds the number of operating hours as a threshold value that leads to the display of the „Operating_time“ service message (02:Information/4,7) when reached.

After maintenance was accomplished, the service message must be reset by setting the „Operating_hours_reset“ parameter (06:Service/10) to „1“ (on). The parameter is set back to „0“ (off) automatically.

For the assessment of the remaining operating hours before maintenance is required, the reading value „Operating_hours_until_msg.“ (06:Service/11) is implemented.

Main contactor

For main contactors, the maximum number of operating cycles is specified by the manufacturer. When a limit value is reached, the corresponding service message is displayed. The main contactor must then be changed and the message has to be reset by setting the "Main_contactor K1_Reset" parameter (06:Service/12).

Table of service parameters

06: Service

No.	Parameter	No.	Adjustment/value range			Meaning/Comment [] explains the term in the glossary →[] refers to a related explanation of the term
			Min	Max	FS	
3	Operating_time_service		0	5000	2500	Preset operating hours (see [37]) until service message is triggered
10	Operating_hours_reset		Selection			Reset operating hours counter?
		0	Off			No
		1	On			Yes
11	Operating_hours_until_msg.			Read value		Remaining number of operating hours until service message is triggered
12	Main_contactor_1_reset		Selection			Reset K1 counter for main contactor operating cycles →[34]
		0	Off			No
		1	On			Yes
13	K1_switching_cycles_until_msg.			Read value		Remaining operating cycles for K1 until service message →[34] is triggered
26	Update_function			Read value		Status of update function [7]
		0	USB-stick_insert			USB stick is not inserted
		1	Loading			The parameter set which is saved on the stick is loaded
		2	Checking			The loaded parameter set is checked
		3	Update			The parameter set is updated
		4	Successful			The update was successful
		5	Data_not_valid			USB stick does not contain a parameter set or parameter set is not compatible

13.8.4.2 Procedure for parameter update

The information below explains how to work with the "Update_function" parameter (see parameter row 26 in the table above).

The update function makes it possible to overwrite parameter settings with a parameter set which is saved on an external USB flash drive. As a result, the operator can make a change without having to change the parameters by themselves. The modified parameter set can be provided by HygroMatik.

The procedure is as follows:

- » With the unit switched on, insert the USB stick into the socket on the mainboard.
- » Call up the "Update function" in the services submenu.

The status of the update process is displayed (see table). Its successful completion is displayed by the "Update successful" status message.

- » Switch the unit off and on again. The loaded parameter set is activated.
- » To reload the parameter set at a later date if required (e.g. after a factory reset), the "ImportDone.txt" file on your USB stick must be deleted beforehand. To do so, the stick must be inserted in an external device (e.g. PC).

If the status "Invalid data" is output after the update operation, a compatible parameter set is not available on the USB stick.

The parameter set that is stored on a USB stick is always linked with a unit serial number and can only be used for this unit.

USB connector on mainboard

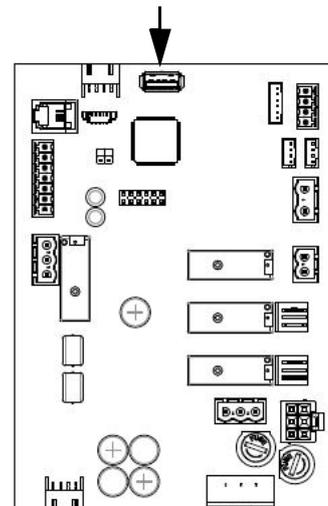

13.8.5 History submenu



The error message history was already described for the basic level in Section 13.6.3. There are no differences at the advanced level.

13.8.6 Functions submenu



Table of functions parameters

10: Functions

No.	Parameter	No.	Adjustment/value range			Meaning/Comment
			Min	Max	FS	
4	Dead_leg_flushing					Selection Solenoid valve of the water inlet and pump/flushing valve are switched on and off in parallel for dead leg flushing [27].
		0				Deactivated Flushing of dead-end line [27] is not carried out
		1				Activated Perform dead leg flushing [27] as required (semi-automatic or fully automatic, depending on device/plant)
5	Dead_leg_flushing_interval		1	5760	1440	Waiting period until start of flushing of dead-end line [27] [min]
6	Dead_leg_flushing_active		1	600	90	Duration of flushing of dead-end line [27] [s]
12	Function_digital_input					Selection Mapping of digital input function [98] to mainboard
		0				Off Not used
		40				Power_limitation Activated digital input [97] by a switch (NO) switches power limitation on for load shedding [101]
		50				Humidification/Cooling If the digital input is activated (switch towards auxiliary voltage closed), exhaust air cooling operation is enabled. In the factory setting for combination systems, however, the setting is not made on the main board, but on the expansion board to which the relevant switch must also be connected (ST05, terminal 8; see terminal connections).
		51				Cooling_on On the combination system, the exhaust air cooling is switched on with the switch connected to ST08 terminal 8 (single-stage operation)
		62				Leakage_sensor The activated digital input [97] monitors the (NC) contact of an external leakage detector. If the contact opens, an error message is shown on the display and humidification is switched off
		90				Relay The digital input [97] activated by a switch (NO) [102] activates a relay if this has been assigned.
15	Delay_humidificat._notif.		0	3600	60	Delay of Humidifying message [s] →[74]
16	Assignment_main_relay					Selection The relay is energised for a message (M) or a switching function (S), if ...
		0				Collective_fault There is any kind of error (M)
		1				Safety_interlock_open The interlock (safety) system [11] is open (M)
		2				No_Demand No demand [5] is present (M)
		3				Humidification Steam production is in progress (M)
		5				Remote_off A remote shutdown was carried out via software command [12] (M)
		6				Safety_interlock_ELV The interlock (safety) system [11] is switched via an additional relay (M)
		7				Safety_interlock_closed The interlock (safety) system [11] is switched as standard (M)
		8				Humidification_off_delay A dropout delay [74] is to be generated following humidification (S)
		12				Standby_signal the device has completed initialization and is not in error (M)
		13				Initialization
		20				Digital_input_active the digital input of the motherboard is activated (M)
		38				Pressure_water_input_min the minimum water inlet pressure is not reached.
		68				Dead_leg_flushing An additionally installed relay is to be actuated, which switches the input solenoid valve for flushing the dead-leg line if the interlock (safety) system is not closed (S)
		150				Loadstage 1 Load level 1 is switched (S)
		151				Loadstage 2 Load level 2 is switched (S)
		152				Loadstage 3 Load level 3 is switched (S)
		154				Cooling Summer operation [62] of the system is performed with exhaust air cooling (S)
		155				Bypass the solenoid valve for the bypass is switched.
		211				Humidity_reached The value set in the Control 21 parameter (Humidity_notification) has been reached (M)
		270				Collective_service A general service message is generated (M)
		274				Service_main_contactor K1 A service is required after the max. operating cycles for K1 have been reached (M)
		283				Service_operating_hours A service is required after the maximum number of working hours has been reached (M)
		284				Not_used The relay is not used and is not controlled.
17	Assignment_relay K20					Selection Relay 1 is one of the top-hat rail relays connected to the ST10.1 connector on the mainboard; assignment is same as for base relay
						see: 10-16 Assignment_main_relay
18	Assignment_relay K21					Selection Relay 2 is the second of the top-hat rail relays connected to the ST10.2 connector on the mainboard; assignment is same as for base relay
						see: 10-16 Assignment_main_relay
19	Assignment_relay K22					Selection Relay 3 is one of the top-hat rail relays connected to the ST10.2 connector on the mainboard; assignment is same as for base relay
						see: 10-16 Assignment_main_relay
20	Assignment_relay K23					Selection Relay 4 is the second of the top-hat rail relays connected to the ST10.2 connector on the mainboard; assignment is same as for base relay
						see: 10-16 Assignment_main_relay

13.8.6.1 Communication interface submenu



The communication interface is a serial RS285 computer interface for the remote control of the high-pressure nozzle system. With this computer interface, all control operations which can be carried out on the screen can also be carried out by the building technology control system, for example.

The MODBUS-RTU Protocol is used to transmit the control commands (separate documentation on this is available from HygroMatik).

Table of communication interface parameters

11: Communication

No.	Parameter	No.	Adjustment/value range			Meaning/Comment [] explains the term in the glossary →[] refers to a related explanation of the term
			Min	Max	FS	
1	Address		0	255	1	Address of the communication interface [13]
2	Baud_rate		Selection			Setting the baud rate
		3	9600			9600
		4	19200			19200
		6	38400			38400
3	Parity		Selection			Parity setting
		0	None			Without parity bit
		1	Odd			Odd parity bit
		2	Even			Even parity bit
4	Stop_bits		Selection			Number of stop bits
		0	1			1 stop bit
		1	2			2 stop bits
5	Modbus_timeout		0	60	20	Timeout in s for software control commands [12] through communication interface [13]
6	BACnet_MacID		1	127	1	Physical address of a BACnet device within the network (s. separate HygroMatik documentation)
7	BACnet_Instance		0	65535	1	Number for the unique addressing of an instance of a specific BACnet object (s. separate HygroMatik documentation)
8	BACnet_Master_max		1	127	127	Specification of the max. qty. of BACnet master devices within the network for avoidance of unnecessary polling actions (s. separate HygroMatik documentation)

13.8.7 Adiabate submenu



Table of parameters for the adiabate functions

15: Adiabatic

No.	Parameter	No.	Adjustment/value range			Meaning/Comment [] explains the term in the glossary →[] refers to a related explanation of the term
			Min	Max	FS	
1	Flush_hygiene		Selection			Flush after waiting time and at the time specified in parameter 15/3.
		1	Waiting time			
		2	Time_of_day			
2	Rinse_Hygiene_Time		00:00	23:59	00:00	Time setting for the execution of the hygiene flush
3	Flush_hygiene_waiting_time		1	2880	1440	Time in minutes to the next obligatory hygiene flush
4	Flush_duration		1	600	20	The duration of the flushing time in seconds (with pump pressure or line pressure according to the setting made beforehand)
5	Relieve_Duration		1	240	5	Determines the duration of the pressure relief [85] in seconds.
6	Delay_reverse osmosis system		10	180	10	Delay between opening the inlet solenoid valve and starting the high-pressure pump. Enables the pressure build-up in the reverse osmosis system.
7	Load_switchover_hysteresis		0,5	5,0	1,0	Hysteresis in % for the changeover points
8	Load_switch_wait		1	10	3	Waiting time in seconds before a load changeover triggered by the request becomes active (to prevent oscillation at the changeover point)

13.8.8 Recording submenu



The control can record 10 data sets^{*)} internally on a rolling basis. For activation, the parameter „Recording“ (16:Recording/1) must be set to „1“ (activated). Snapshots of the unit status are then carried out at intervals of 10 s, which can be helpful for troubleshooting. When all memory slots are filled, a new set of data overrides the oldest entry. A recorded set of data is conserved for a period of max. 7 days.

The complete record [93] can be saved to a USB stick with FAT32 formatting.

For saving, pls. proceed as follows:

For saving, pls. proceed as follows:

- » Call up recording submenu.
- » Insert USB stick in connector on mainboard (s. drawing below).
- » Set parameter „Saving_start“ (16:Recording/2) to „1“ (on). Saving starts automatically. Then, parameter „Saving_start“ returns to the „0“-state (Off).

USB connector on mainboard

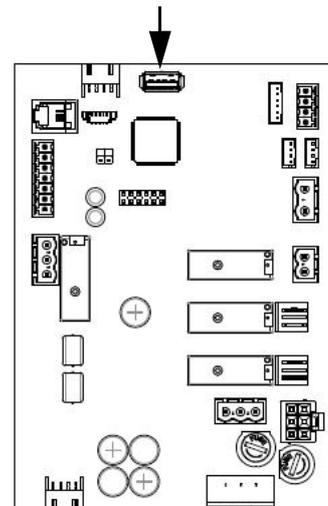

By looking at parameter „Saving_status“ (16:Recording/4) the **status** of the saving procedure can be checked. „1“ (Activated) means that writing to the memory stick is underway.

Erasing of the complete memory is achieved by setting the „Recording_delete“ parameter (16:Recording/5) to „1“ (On).

Please note

During the erasing of the recording memory, the display possibly shows a „?“ since no access to the unit parameters is made.

^{*)} A data set consists of the following values:

Status_unit
 Fault_message_unit
 Safety_interlock
 Demand
 Humidity_actual_value
 Humidity_set_value
 Humidity_actual_max ^{**)}
 Humidity_set_max ^{**)}
 Pressure_actual_value
 Pressure_set_value
 Frequency_set_value
 Load_actual

^{**)} only when the floating max. limiter is in use

Table of recording functions

16: Recording

No.	Parameter	No.	Adjustment/value range			Meaning/Comment [] explains the term in the glossary →[] refers to a related explanation of the term
			Min	Max	FS	
1	Recording		Selection			Recording [93] of parameter sets
		0	Deactivated			No recording
		1	Activated			Start recording
2	Saving_start		Selection			Saving of the existing recording on a USB stick
		0	Off			No action
		1	On			Start saving process
3	Saving_abort		Selection			Cancel saving
		0	Off			No action
		1	On			Cancel saving process
4	Saving_status		Read value			Status of saving process
		0	Deactivated			Saving not possible
		1	Activated			Saving is enabled
5	Recording_delete		Selection			Delete recording
		0	Off			No action
		1	On			Delete recording

13.8.9 Submenu Cylinder extension

*)

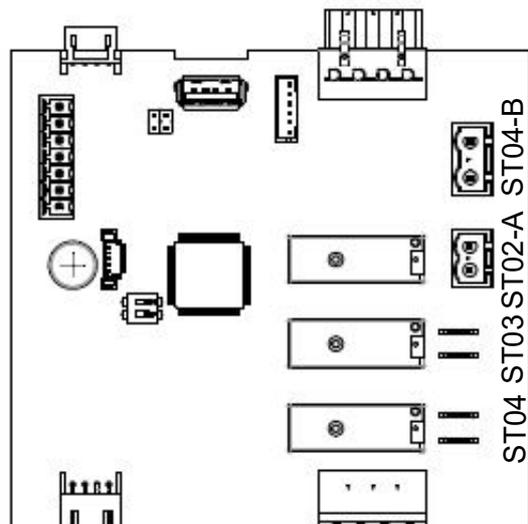

Table of the parameters for the expansion board

17: Cylinder extension

No.	Parameter	No.	Adjustment/value range			Meaning/Comment [] explains the term in the glossary →[] refers to a related explanation of the term
			Min	Max	FS	
1	Digital_input_function		Selection			Assignment of the digital input function [98] of the digital input [97] on the cylinder extension board
			see: 10-12 Function_digital_input			

*) s. note in section 11.6.3.2

13.9 Screen 4 - Unit information

After an error or a status message has occurred, a display which provides information about the type of message appears in the main screen instead of the HygroMatik logo. The content of the message is described in Section 14.

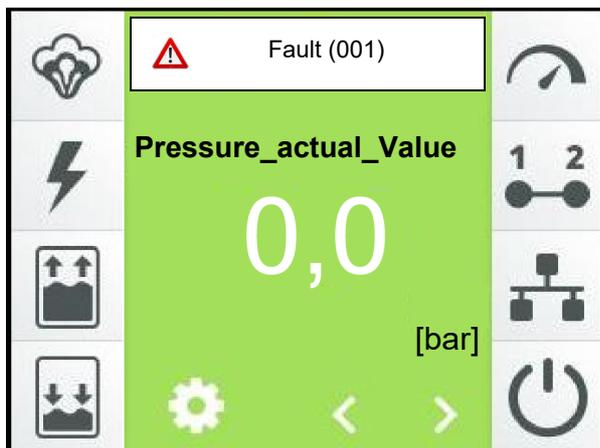

Touching this display field calls up the unit info screen which extends over several screen pages and contains comprehensive device data. As an example, one possible first screen page is shown here:

02: Information	
01: Error message_unit	Pressure_sensor
04: Service message_unit	No_service_message
07: Unit type	HPS250-L1
08: Unit name	Unit 1

The content of the screen pages is provided in the table in the next section.

Entries on the unit info screen

02: Information

No.	Parameter	No.	Adjustment/value range			Meaning/Comment
			Factory setting (FS) Bold			
			Min	Max	FS	
1	Fault_message_unit		Read value			List of possible unit fault messages
		0	No_fault			No fault
		10	Plug_ST09			Connector ST09 on the main board is not plugged in.
		22	Input_current_min.			Minimum value of current input not plausible
		24	Input_resistance_OC			Minimum value of resistance input/NTC input not plausible
		25	Input_resistance_SC			Maximum value of resistance input/NTC input not plausible
		29	Internal			System fault
		150	Pressure_sensor			Values provided by pressure sensor not plausible
		151	Pressure_max.			Maximum pressure exceeded
		152	Pressure_min.			Minimum pressure not reached
		153	Pressure_water_inlet			Water inlet pressure too low
		154	Leakage_pump_station			Leakage detected in the pump station
		155	Frequency_converter			Frequency inverter displays error message
		156	Temperature_engine			Motor temperature too high
		157	Temperature_housing			Housing temperature too high
		158	Temperature_pump			Pump temperature too high
		210	Humidity_sensor			Humidity sensor, cable or input level defective
		211	Humidity_sensor 2			Humidity sensor 2, cable or input level defective
4	Service_message_unit		Read value			Service message unit
		0	No_service_msg.			A service is not required
		2	Cycles_main_contactor 1			The maximum number of operating cycles for K1 has been reached and a Service_main_contactor [34] is required
		7	Operating_time			A service is required due to the number of operating hours
		15	Pressure_water_input_min			The water inlet pressure is below the specified minimum value. The high pressure pump operation is on hold until the pressure has maintained the minimum value for the period defined in parameter 15/14. The occurrence of the service message is recorded in an internal counter. If the service message has occurred 5 times, the fault message 'Pressure_water input' (02/1, no. 153) is raised. The internal counter is counted down by '1' each time when the water input pressure has not fallen below the minimum value for a contiguous period of 10 minutes.
		16	Nozzles			The nozzle condition of the spraying system requires maintenance
		18	Control			The control of the humidifier should be optimized.
		19	Pressure_set_value			The actual pressure falls below the target pressure by > 1bar for at least 180s at one frequency of 50Hz. Cause: slight leaks in the Area of nozzles and tubing as well Pump wear. This service notification solves no mistake. The system continues to run until the Minimum pressure is no longer reached. Then the system stops with error message 152. Review and eliminate existing ones Leaks or replace the pump out.
		20	Pressure_water_input_max			The water inlet pressure is above the specified maximum value. The high-pressure pump is stopped until the pressure drops below the maximum value again.
		23	Dampfmenge_abgelaufen			
		24	Sicherheitsabschaltung			
		25	Hygrostat			
		26	Luftströmung			
		27	Leakage			
7	Model		Read value			Type designation of unit
8	Unit_name		Read value			Unit name [90], can be selected by the customer, if required
9	Serial_number		Read value			Serial_number
10	Date_of_manufacturing		Read value			Date_of_manufacturing
11	Software_version		Read value			Software version of control
12	Production_total_time		Read value			Total duration of steam production since initial operation (specified in days/months/years/hours/minutes)
13	Unit_total_runtime		Read value			The total runtime of the unit since its first connection to the power supply (specified in days/months/years/hours/minutes)
18	Service_Reset		Selection			Reset all service messages?
		0	Off			No
		1	On			Yes

14. Faults

14.1 Fault Management

In the event of a fault, the humidification/cooling is halted. The relevant display field is then shown instead of the HygroMatik logo. The display field shows a warning symbol, the „Fault“ message and - in paranthesis - the fault code:

e.g.:



When touching the fault message display field, the unit info screen opens with the fault message in plain text and information concerning the unit and its current state.

The majority of fault messages is additionally accompanied by the flashing of one or more icons, allowing for a first limitation of the cause of fault.

14.1.1 Table of fault messages, possible causes and counter-measures

These icons flash	Fault Code	Fault message	Possible cause	Counter measure
	002	Expansion board Expansion board not detected by the software	<ul style="list-style-type: none"> • p.c.b. connection not o.k. • p.c.b. not present or defective • CAN bus addressing not correct 	<ul style="list-style-type: none"> • Check firm connection of boards • Connect board, replace board if defective • Check DIP switch settings on extension board (see fig. in section 3.4).
	022 *)	Input_current_min The min. value of the input signal is no plausibel	<ul style="list-style-type: none"> • Sensor, wiring or signal source defective 	<ul style="list-style-type: none"> • Check sensor, wiring and signal source, if relevant
	024 025 *)	Input_resistance_OC Input_resistance_SC The resistance measured is not correct („infinite“ or „zero“, resp.)	<ul style="list-style-type: none"> • Sensor, wiring or signal source defective • Input stage defective 	<ul style="list-style-type: none"> • Check sensor, wiring and signal source, if relevant • Replace mainboard

*) When the PI controller is in use, fault codes 022 to 025 relate to the sensor. In case of an external controller, the signal source is referred to.

These icons flash	Fault Code	Fault message	Possible cause	Counter measure
*) When the PI controller is in use, fault codes 022 to 025 relate to the sensor. In case of an external controller, the signal source is referred to.				
	029	Internal System failure	<ul style="list-style-type: none"> • Mainboard is defective 	<ul style="list-style-type: none"> • Replace mainboard
	150	Pressure sensor The pressure sensor delivers values outside the normal range	<ul style="list-style-type: none"> • HP pressure sensor cable not connected • Pressure sensor defective • Broken wiring 	<ul style="list-style-type: none"> • Check cable connection and make correction, if required • Replace pressure sensor • Check wiring and fix, if required
	151	Max. pressure The feed pressure of the pressurised water has exceeded 75 bar for a period of 90 secs	<ul style="list-style-type: none"> • Nozzles clogged • Overpressure protection on high-pressure pump not properly set 	<ul style="list-style-type: none"> • Clean or replace nozzles • Please contact HygroMatik
	152	Min. pressure Pressure cannot be built up within 90 seconds after actuation of the high-pressure pump	<ul style="list-style-type: none"> • Pressure hose leaky • Overpressure protection on high-pressure pump not properly set • Pressure variations in RO device • Loss of performance of the pump due to wear 	<ul style="list-style-type: none"> • Check pressure hose and replace, if required • Please contact HygroMatik • Check RO device • Replace pump
	153	Water inlet pressure Water inlet pressure is below 1 bar	<ul style="list-style-type: none"> • Water supply not yet connected • Water filter polluted • Pressure variations in RO device 	<ul style="list-style-type: none"> • Connect water supply with pressure between 1 and 5 bar • Check filter and replace, if required • Check RO device
	154	Pump leakage Water/oil has leaked from the pump and the float switch trips	<ul style="list-style-type: none"> • Pump is leaking • Float switch is stuck 	<ul style="list-style-type: none"> • Replace seals or pump, if required • Check float switch

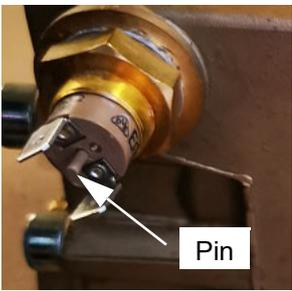
These icons flash	Fault Code	Fault message	Possible cause	Counter measure
	155	Frequency inverter The frequency inverter has produced an error message	<ul style="list-style-type: none"> • Overload on the motor • Motor cable short-circuited • Error in the frequency inverter electronics • Earth fault of output terminals 	<ul style="list-style-type: none"> • For fault elimination, please follow the instructions in the documentation of the frequency inverter (may be requested from HygroMatik)
	156	Motor temperature Temperature control of the motor winding tripped because of excessive temperature	<ul style="list-style-type: none"> • Air inlets and outlets clogged 	<ul style="list-style-type: none"> • Remove blockage(s)
	157	Cabinet temperature The temperature sensor in the housing cabinet measures a temperature above 50°C +/-10%	<ul style="list-style-type: none"> • Air inlets and outlets clogged 	<ul style="list-style-type: none"> • Remove blockage(s)
	158	Pump temperature Thermoswitch on high-pressure pump has tripped after temperature exceeded 60 °C.	<ul style="list-style-type: none"> • Nozzles or hoses blocked by e.g. debris • Incorrectly set bypass • Ventilation of the housing not existent 	<ul style="list-style-type: none"> • Clean nozzles and/or pressure hoses • Check and set the bypass valve to 9 Hz at a 1 V control signal • Check housing ventilation • Following any of the actions above, reset the thermo switch by pushing the pin in the position shown below:
				
	210 211	Humidity_sensor Humidity_sensor 2 The value of a connected humidity sensor (option) is outside the normal range.	<ul style="list-style-type: none"> • Humidity sensor defective • Line break 	<ul style="list-style-type: none"> • Replace humidity sensor • Replace line

14.2 Service messages

Service messages are shown (just as the fault messages) on the main screen in place of the HygroMatik logo, when the cause has occurred.



When tipping the display field, the unit info screen is shown with the messages in plain text.

Message	Possible cause	Countermeasure
Cycles_main_contactor K1	The maximum number of operating cycles for the main contactor K1 has been reached.	The main contactor should be changed. After replacement, the respective counter must be reset with the parameter „Main_contactor_K1_Reset“
Operating_time	The number of operating hours preset has been reached.	Maintenance is required.
Pressure_water_input_min	The water inlet pressure lies under the specified minimum.	The high-pressure pump is stopped until the water inlet pressure has kept its minimum value for the time period defined by parameter 15/14. The appearance of the service message increments an internal counter. Whenever this counter shows 5 entries, the fault message „water inlet pressure (02/1, no. 153) is generated. The internal counter is decremented each time when the water inlet pressure has not undercut its specified minimum for 10 mins without interruption.
Service_Nozzles	The spray system nozzles are not working at their optimum.	Maintenance is required.
Service_Control	The control signal setting is not at its optimum.	Check control signal parameters.
Pressure_set_value	Leakage or loss of pump power	The actual pressure falls below the set pressure by >1bar for at least 180s at a frequency of 50Hz. Cause: slight leaks in the nozzle and hose area as well as pump wear. This service message does not trigger an error. The system continues to run until the minimum pressure is no longer reached. Then the system stops with error message 152. Check and eliminate existing leaks or replace the pump.
Pressure_water_input_max	Water supply is not orderly.	Optimise water supply.

15. Maintenance

The high-pressure nozzle system is maintenance-friendly. However, operational faults which can be traced back to inadequate or improper maintenance may occur.

Regular maintenance of the high-pressure nozzle system is indispensable for ensuring long service life

▲ WARNING

Risk of electrical Shock!

Hazardous electrical voltage!

Unit must be switched off and protected against restart by expert staff (electricians or expert personnel with equivalent training) before any maintenance work is commenced.

15.1 Maintenance activities

For the system to operate without any problems the following checks and maintenance tasks must be carried out regularly:

1 x per month:

- » Check water tray and housing for contamination and clean if necessary.
- » Carry out a visual inspection of aerosol separators and clean if necessary.
- » Check the high-pressure pump oil level.
- » Check the water filter cartridge upstream of the pump group for contamination and replace if necessary; flush the mains water system if necessary.
- » Check the resulting spray cone of the nozzles and clean nozzles if necessary (also see section „Cleaning the high-pressure nozzles“).

1 x per year (or after 2500 h):

- » Check the nozzles as part of annual maintenance and clean in an ultrasonic bath (also see section „Cleaning the high-pressure nozzles“). Replace nozzles, if required.
- » Change the high-pressure pump oil.
- » Change sealings and valves of the high-pressure pump.
- » Replace water filter cartridge
- » Carry out a visual inspection of the the spray system, the aerosol separators and the humidification chamber; clean if necessary.
- » Check the function of the switch-off devices.

Please note

After a shutdown period of more than three months, maintenance with cleaning of the spraying system as well as an oil and O-ring change at the high pressure pump to be done.

Please note

With the pumps used, the seals wear (depending on the degree of utilisation). Leakages occurring can be repaired by replacing the seals. In such a case, contact HygroMatik.

15.1.1 Changing the oil in the high-pressure pump

An oil change on the high-pressure pump must be carried out once a year (or every 2500 operating hours). If contamination is visible through the oil sight glass the oil may have to be changed more frequently.



Oil filler hole with dipstick



Position of drain screw

Changing the oil:

- » Switch off the high-pressure nozzle system by setting the main switch on the control cabinet to position „0“.
- » Unscrew the oil dipstick (1).
- » Open the drain screw (2) and let the oil drain. Pay attention to the sealing.
- » Tighten the drain screw (2) with the sealing ring in place.

NOTICE

Risk of material damage to the high pressure pump caused by inadequate oil filling!

Only use **mineral oil!**

- » Add 15W40 motor oil (approx. 0.4 l) via the filler hole (1).
- » Check the oil level using the dipstick and close the filler hole.
- » The unit is now ready for restart by pushing the control switch to the „I“ position.

15.1.2 Checking/replacing the mains water filter

The mains water filter must be checked monthly for contamination and replaced when necessary. Colouring of the originally white water filter indicates contamination. hin.

Contamination results in an increased resistance to flow. This lowers the supply pressure to the pump. An excessively low supply pressure can lead to switch-off of the high-pressure nozzle system (dry run protection).

Replacing the water filter:

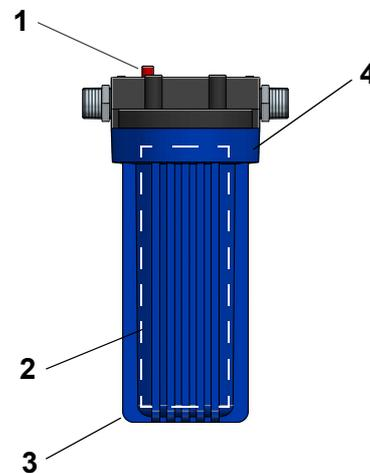

- (1) Venting button
- (2) Filter cartridge (inboard)
- (3) Filter housing
- (4) Holding of filter housing

- » Set the control switch on the control cabinet of the high-pressure nozzle system to „0“.
- » Close the supply water stopcock upstream of the water filter.
- » Relieve the line pressure (press red button on the water filter cover).
- » Open the filter housing by hand. The thread may be damaged if pliers are used.
- » Clean the filter housing.
- » Replace the filter cartridge (if necessary).
- » Screw the filter housing into the seat by hand

Please note

Do not pinch the sealing ring.

- » Open the supply water stopcock.
- » The unit is now ready for restart by pushing the control switch to the „I“ position.

15.1.3 Flushing the mains water system

- » Set the control switch on the control cabinet of the high-pressure nozzle system to „0“.
- » Close the fresh water water stopcock upstream of the water filter.
- » Remove the connector for the fresh water supply to the pump group.
- » Open the fresh water stopcock and flush the water line until the water appears to be free of contamination.
- » Close the fresh water stopcock.
- » Reconnect the fresh water supply to the pump group.
- » Open the fresh water stopcock.
- » The unit is now ready for restart by pushing the control switch to the „I“ position.

15.1.4 Cleaning the high-pressure nozzles

▲WARNING

Risk of injury due to high pressure remaining in the tubing.

Ensure that the high pressure is reduced by e.g. activating the flushing program.

- » Set the control switch on the control cabinet of the high-pressure nozzle system to „0“.
- » Unscrew the nozzle (1) from the holder.
- » Screw the nozzle inside part (2) out.
- » Remove nozzle insert (3).

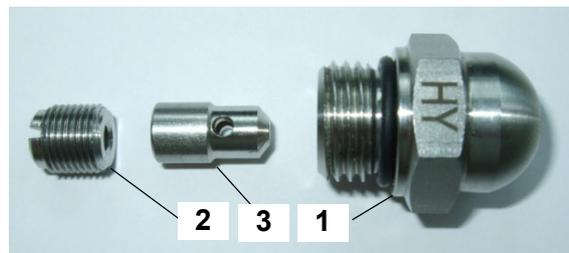

▲WARNING

Risk of eye injuries (acid burn)!

Wear proper PPE (Personal Protection Equipment = safety goggles) when cleaning the high-pressure nozzles!

- » Clean the nozzle components in an ultrasonic bath for about 10 minutes, if necessary use a lime remover in low concentration (less than 10%).
- » Put nozzle components back together.
- » The unit is now ready for restart by pushing the control switch to the „I“ position.

15.1.5 Cleaning the aerosol separators

The aerosol separators should be checked every 4 weeks for possible contamination and cleaned if necessary. The aerosol separators should be thoroughly cleaned at least once a year.



- » Set the control switch on the control cabinet of the high-pressure nozzle system to „0“.
- » Pull or lift the aerosol separators out of the guide rails.
- » Clean the aerosol separators with a cleaning agent and then rinse and dry them.
- » Carry out a visual inspection of the aerosol separators, repeat the cleaning step if necessary and replace the aerosol separators if damaged.
- » Place the aerosol separators back on the guide rails. While doing so ensure that the trap frame drain holes are facing downwards to guarantee free drainage.
- » The unit is now ready for restart by pushing the control switch to the „I“ position.

15.1.6 Cleaning the spray system

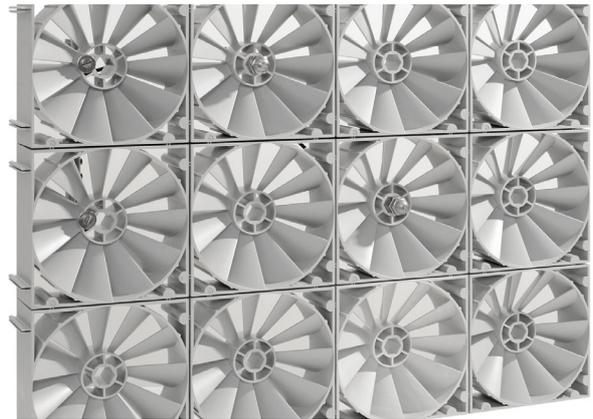

The spray system should be checked for contamination and damage every 4 weeks. Any contaminants must be removed with an alkaline-based cleaning agent basis that meets the VDI 6022 requirements. The spray system should be thoroughly cleaned at least once a year.

15.1.7 Cleaning the mounting profiles

The mounting profiles of the spray system and the aerosol separators should be reviewed as a part of the annual maintenance for contamination or damage. Possible impurities must be removed with a cleaning agent.

15.1.8 Cleaning the humidification chamber

- » Clean the humidification chamber and the base tray as required with the cleaning agent that is recommended by the manufacturer of the humidification chamber.
- » After cleaning, rinse and let dry.

NOTICE

Risk of material damage!

When cleaning the spray system, do not aim the water jet at the aerosol separators. Any upstream or downstream heating or cooling units must not become wet during cleaning.

15.2 Extended service instructions

15.2.1 Replacing the shaft sealing ring of the high-pressure pump EH2009

To remedy any oil leakages on the shaft output side of the high-pressure pump, the shaft sealing ring must be replaced.

Dismantling

- » Close the fresh water water stopcock.
- » Switch-off unit by means of control switch.
- » Open the drain screw (2) (pay attention to the sealing).

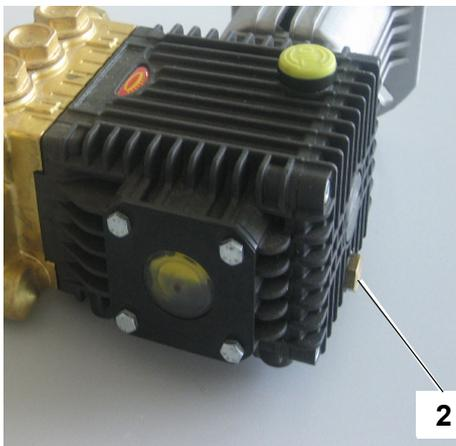

Position of drain screw

- » Let the oil drain and dispose according to legal regulations.

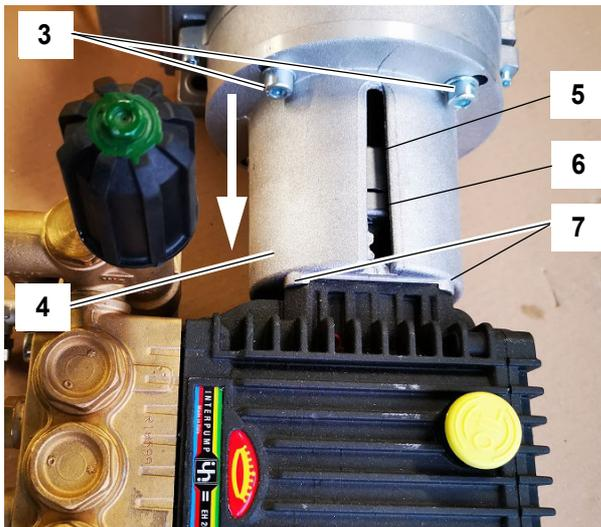

High-pressure pump with coupling bell on motor

- » Dismantle the water connection lines of the high-pressure pump
- » Remove the 4 fixing screws (3) (2 screws are hidden in fig.) of the coupling bell and separate the coupling bell with the pump from the motor (pull in the direction of the arrow in the fig.)
- » Place the high-pressure pump with the coupling bell on a suitable surface.

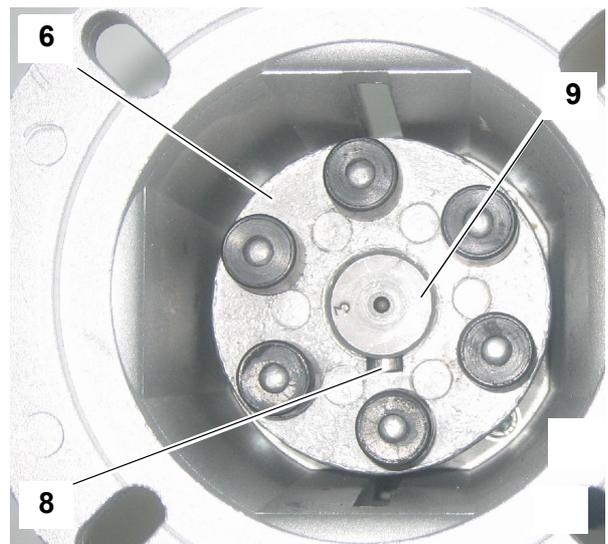

Inner sight of the coupling bell with pump shaft and coupling piece

- » Rotate pump shaft (9) until the laterally attached securing screw (8) is visible through the slot (5) of the bell-shaped top.
- » Loosen screw (8) and pull the coupling piece (6) from the shaft (9).
- » Loosen the 4 screws (7) that hold the coupling bell housing (4) from the inside of the coupling bell and remove the bell-shaped top from the high-pressure pump.

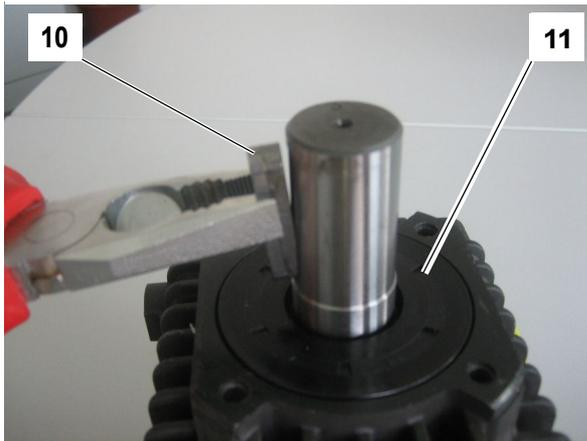

Key and shaft sealing ring

NOTICE

Risk of material damage to the pump!
When removing the shaft sealing ring, take care not to damage the seat and the shaft!

- » Remove key (10) and lever the shaft sealing ring (11) with a suitable tool from its seating.

NOTICE

Risk of material damage to the pump shaft!
Do not use any hard implements.

- » Carefully remove any residues of material left by the sealing ring from the shaft.

Reassembly

- » Position new sealing ring on the shaft by rotating movements and press it evenly in its seat.
- » Perform the rest of the steps for assembly in reverse order of the dismantling.
- » Remount oil drain screw (2) paying attention to the sealing ring.

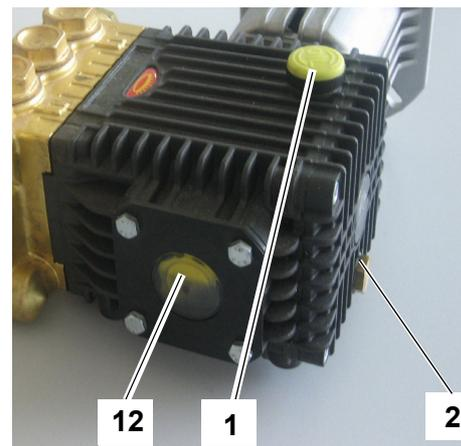

Filler hole, sight glass and drain screw

- » Fill the pump with suitable **mineral oil** of the specification **15W-40** through the filler hole (1) until the sight glass (12) is a max. of 3/4 full (filling capacity approx. 0.4l).

15.2.2 Replacing the valves

The high-pressure-pump has 3 identical valves on the low-pressure and high-pressure side. If the pump can no longer build up the required pressure, worn valves may be the cause. To replace the valves, *Replacement kit KIT123* is required which includes 6 valves and 6 O-rings.



Valve holders (6 pcs.)



O-Ring in valve seat

- » For reassembling, lay the new O-ring (15) in the valve seat.
- » Put the valve into the holder.
- » Screw the holder with the valve into the pump.

Method

- » Disassemble the valve holders (13) with a suitable tool.
- » Detach valve (14) from valve holder (13) (6 valves).
- » Remove O-rings (15) in the valve seat with a small screw driver or similar.



Valve holder and valve (removed and separated)

15.2.3 Replacing the seals on the water side

If water leaks occur on the pump, the seals must be replaced. In order to do this, the water supply must be turned off, the system must be switched off at the main switch and the water connection hoses must be dismantled from the pump.



Valve block securing screws (8 pcs.)

Method

- » Remove the 8 screws (15).
- » Separate valve block from drive block.

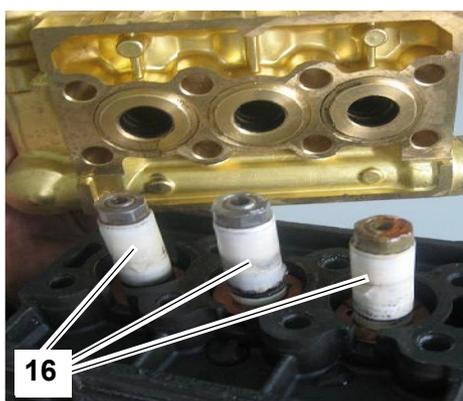

Ceramic plungers

- » Carefully free the ceramic plungers (16) of seal deposits with the included polishing wool, check them for signs of wear and replace if necessary.

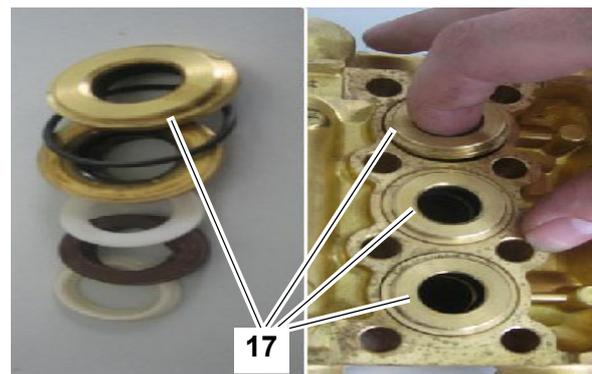

Sealing parts

- » Remove all sealing parts (17) and replace by means of *KIT160* or *KIT166* in the pumps.

Please note

KIT160 contains all the seals required for replacing the plunger sealing of a pump. In the event that the metal parts of the sealing are also defective, *KIT166* must be used, of which 3 pieces are required for each pump.

- » Assembly is carried out in reverse order. To insert the seals suitable tools have to be used.

15.2.4 Calibration work after repair or replacement of the high-pressure pumpstation

15.2.4.1 Setting of the overpressure protection

Overpressure protection setting is restricted to a basic setting for the unit operator.

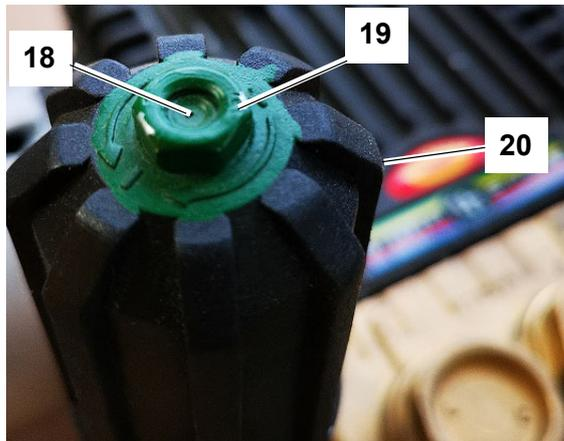

Rotary handle of the overpressure protection with stop adjustment

Method

- » Switch-off unit making use of the control switch.
- » Turn overpressure protection rotary handle (20) counterclockwise until it almost comes off.
- » Screw-in headless Allan screw (18) until it is flat with the locknut (19) and secure in this position.
- » Turn rotary handle (20) in clockwise direction until stop.
- » The unit is now ready for restart by pushing the control switch to the „I“ position.

15.2.4.2 Setting of the optional by-pass valve on the distribution manifold

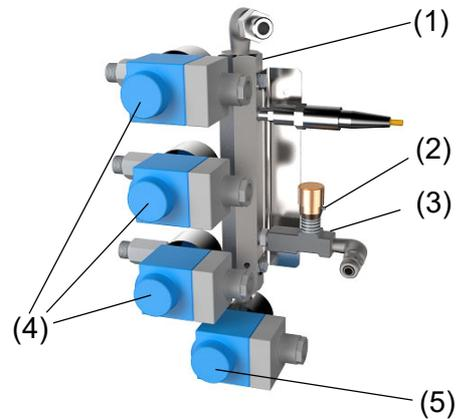

- 1 - Distribution manifold
- 2 - Headless Allan screw
- 3 - By-pass valve
- 4 - Solenoid valves for pressure hoses
- 5 - Rinse valve

Method

- » Apply control signal $\geq 1.5 \text{ V}$
-> unit starts operation.
- » Reduce control signal to approx. 1 V
-> pressure sinks to 25 bar.
- » Unfasten headless Allan screw (2) on by-pass valve (3) and adjust valve slowly until a frequency between 9 and 12 Hz can be read in the frequency converter display.
- » Fasten Allan screw again for securing the setting.
- » Return to the normal operation settings should they have been changed.

16. Declaration of Conformity

EG-Konformitätserklärung EC Declaration of Conformity

Hersteller / Manufacturer: HygroMatik GmbH

Anschrift / Address: Lise-Meitner-Straße 3, D-24558 Henstedt-Ulzburg, Germany

Produktbezeichnung / Product description:
High Pressure System: HPS250, HPS500

In den Ausführungen / Type: 1-4 Lasten proportional, 1-3 Lasten proportional und Kühlung
1-4 loads proportional control, 1-3 loads proportional control and cooling

Die bezeichneten Produkte stimmen in der von uns in Verkehr gebrachten Ausführung mit den Vorschriften folgender Europäischer Richtlinien überein:

The products described above in the form as delivered are in conformity with the provisions of the following European Directives:

2014/30/EU Richtlinie des Rates zur Angleichung der Rechtsvorschriften der Mitgliedstaaten über die elektromagnetische Verträglichkeit.
Council Directive on the approximation of the laws of the Member States relating to electromagnetic compatibility.

2014/35/EU Richtlinie des Rates zur Angleichung der Rechtsvorschriften der Mitgliedstaaten betreffend elektrische Betriebsmittel zur Verwendung innerhalb bestimmter Spannungsgrenzen.
Council Directive on the approximation of the laws of the Member States related to electrical equipment designed for use within certain voltage limits.

Die Konformität mit den Richtlinien wird nachgewiesen durch die Einhaltung folgender Normen:
Conformity to the Directives is assured through the application of the following standards:

Referenznummer:	Ausgabedatum:	Referenznummer:	Ausgabedatum:
<i>Reference Number:</i>	<i>Edition:</i>	<i>Reference Number:</i>	<i>Edition:</i>
DIN EN 61000-6-2	2006-03	DIN EN 60335-1	2012-10
DIN EN 61000-6-3	2011-09	DIN EN 60335-1 Ber.1	2014-04
DIN EN 62233	2008-11	DIN EN 60335-2-98	2020-05
DIN EN 62233 Ber.1	2009-04	VDI 6022-1	2018-01
		VDI 3803-1	2010-02

Das Produkt entspricht den Anforderungen des deutschen Produktsicherheitsgesetzes ProdSG hinsichtlich der Gewährleistung von Sicherheit und Gesundheit. Produktänderungen nach Auslieferung können zum Verlust der Konformität führen.
The requirements of the German Product Safety Law ProdSG regarding the ensurance of safety and health are met. Product modifications after delivery may result in a loss of conformity.

Henstedt-Ulzburg, den / the 07.07.2021

HygroMatik GmbH

Dirc Menssing
Geschäftsführer / General Manager

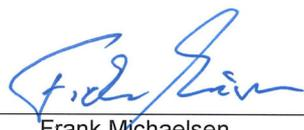
Frank Michaelsen
Technischer Leiter / Head of Engineering

Diese Erklärung bescheinigt die Übereinstimmung mit den genannten Richtlinien, ist jedoch keine Zusicherung von Eigenschaften. Die Sicherheitshinweise der mitgelieferten Produktdokumentation sind zu beachten.
This declaration certifies the conformity to the specified directives but contains no assurance of properties. The safety documentation accompanying the product shall be considered in detail.

17. Spare parts

HPS250	HPS500	Article. No.	Description
			Electrical main assembly
x	x	CN-07-00020	Mainboard [Modbus]
x	x	CN-07-00021	Display Touch
x	x	CN-07-00030	Extension board double cylinder units
x	x	CN-07-00066	Main contactor 20A AC1
x	x	CN-07-00059	Main contactor 16A AC1
x	x	CN-07-00210	Circuit breaker B 16A, 1+N, 10kA
x	x	CN-32-01001	High pressure sensor 0 - 100 bar, 4-20mA
x	x	CN-32-01002	Leakage detector
x		CN-32-01003	Frequency converter incl. keypad
	x	CN-32-01004	Frequency converter incl. Keypad
			Pressure generation
x		PP-32-01010	High pressure pump complete
x		PP-32-01011	Motor 1,1kW
x		PP-32-01012	High pressure pump incl. pressure control set, thermostwitch andrubber parts clutch
x		PP-32-01013	High pressure pump without attachments
	x	PP-32-01020	High pressure pump complete
	x	PP-32-01021	Motor 1,1kW
	x	PP-32-01022	High pressure pump incl. pressure control set, thermostwitch andrubber parts clutch
	x	PP-32-01023	High pressure pump without attachments
x	x	PP-32-01030	overpressure protection
x	x	PP-32-01001	ByPass valve
x	x	PP-32-01002	Thermal circuit breaker pump
			Water inlet
x	x	WF-32-01001	Solenoid valve water feed HPS incl. connectors
x	x	WF-32-01002	Pressure switch HPS water inlet, setpoint 1bar
x	x	E-7800422	Hose PA, 10x7mm, black, max. pressure 23bar
			Water drain
x	x	WO-32-01001	Solenoid valve, highpressur 2-100 bar
x	x	WO-32-01002	Coil for HiPres-solenoid valvel 230V/ 50Hz
			Maintenance
x	x	B-7621029	Maintenance set water-prefilter for HPS und LPS
x	x	E-7621026	Repair kit KIT 123 to consist of 6 valves for highpressure pump EH2009/EH1416
x	x	B-7621003	Repair kit KIT 160 water seals pump [EH2009/EH1416 HDS-1100, HDS-1100-P/2200-P]
x	x	OIL	For maintenance of HPS pumps use only mineral oil 15W40
			Spray system
x	x	B-7771361	Highpressure water distributert 8 adapters, Length 450 mm complete inkl. mountig set
x	x	B-7771363	Highpressure water distributert 16 adapters, Length 450 mm complete inkl. mountig set
x	x	E-7701000	Vortex-module
x	x	E-7700558	Adjustable stud barrel tees EL-VD 06 L, stainless steel
x	x	B-7800311	Spraying nozzle HY 0.27/ 120°, incl.- O-Ring, LPS / HDS / HPS
x	x	B-7800313	Spraying nozzle HY 0.27/ 60°, incl.- O-Ring, LPS / HDS / HPS
x	x	E-7601572	O-ring, 70° Shore, EPDM, for vakuu valve VV8 and for HDS/LPS Nozzle
x	x	B-7771053	HDS nozzle holder complete with o-rings and connector for 120°/60° nozzle
x	x	AC-33-00100	mounting kit Vortex-Wall
x	x	B-7776402	Hose inlet fitting for humidification chamber HDS
x	x	E-7706054	Hose, high pressure, DN 04 mm length 1750 mm connection distributor pipe - nozzle for HPS-systems
x	x	E-7706052	Hose, high pressure, DN 04 mm length 1330 mm connection distributor pipe - nozzle for HPS-systems
x	x	E-7706048	Hose, high pressure, DN 04 mm length 960 mm connection distributor pipe - nozzle for HPS-systems
x	x	E-7706046	Hose, high pressure, DN 04 mm length 820 mm connection distributor pipe - nozzle for HPS-systems
x	x	E-7706044	Hose, high pressure, DN 04 mm length 640 mm connection distributor pipe - nozzle for HPS-systems
x	x	E-7706042	Hose, high pressure, DN 04 mm length 440 mm connection distributor pipe - nozzle for HPS-systems
x	x	E-7706040	Hose, high pressure, DN 04 mm length 370 mm connection distributor pipe - nozzle for HPS-systems
x	x	WO-32-06062	Hose, high-pressure DN08 mm, length 2 m incl. Double-nipple 3/8" 60° cone
x	x	WO-32-06064	Hose, high-pressure DN08 mm, length 2,5 m incl. Double-nipple 3/8" 60° cone
x	x	WO-32-06066	Hose, high-pressure DN08 mm, length 4 m incl. Double-nipple 3/8" 60° cone
x	x	WO-32-06068	Hose, high-pressure DN08 mm, length 6 m incl. Double-nipple 3/8" 60° cone
x	x	WO-32-06070	Hose, high-pressure DN08 mm, length 8 m incl. Double-nipple 3/8" 60° cone
x	x	WO-32-06072	Hose, high-pressure DN08 mm, length 10 m incl. Double-nipple 3/8" 60° cone
x	x	WO-32-06074	Hose, high-pressure DN08 mm, length 14 m incl. Double-nipple 3/8" 60° cone
x	x	WO-32-01367	T-piece 3/8" HPS with 2x hose connector, 3/8", 60° conical seat to split one Load to two VortexWalls
x	x	WO-32-05536	HPS Srew-in fitting 90° 3/8" 60° conical seat one side nut 3/8" connection between HPS and HP-Hose

For ordering spare parts you find a template on the www.hygromatik.com website under the „Contact“ tab.

Your spare parts order can also be sent directly per e-mail to hy@hygromatik.de.

Please make sure to specify your unit model and serial number.

18. Technical specifications

High-pressure nozzle system HPS			
Typ		250	500
Effective output power	[kg/h]	up to 250	up to 600
Electrical connection	[V/Ph/Hz]	230/1/N/50 - 60	
Power rating	[kW]	1,48	2,4
Nominal current	[A]	6,45	10,4
Control signal ¹⁾	[V/mA/Ω]	0 - 10 / 0 - 20 / 0 - 140	
number of nozzles		6 - 39	18 - 104
Humidification section length, ideally	[m]	0,9	
Total installation length, ideally	[m]	1,5	
Air velocity	[m/s]	0,9...2,8	
Pressure loss in duct	[Pa]	80 @ 2,0 m/s	
Pump station height	[mm]	734	
Pump station width	[mm]	782	
Pump station depth	[mm]	399	
water conection		demineralised water remaining conductivity 5-50 µS/cm	

¹⁾ other control signals on request

19. Glossary

Term	[Index]	Explanation
Actual value	1	The actual value is the measured value of a physical quantity, which is compared with the → <i>Set value</i> [3] during the control process and may give rise to a readjustment, if required.
Relative humidity (r.h.)	2	The relative humidity (r.h.) describes the maximum percentage of moisture which the ambient air can hold at a certain temperature.
Set value	3	The set value of a physical quantity (e.g. the → <i>r. h.</i> [2]) is the set target for a control process.
Humidification output	4	
Demand	5	The demand describes the dimensionless control signal processed by the control system which is converted into a proportional → <i>Internal actuator signal</i> [42] for the power control for steam generation.
Hygrostat	6	Sensor with switching function for the → <i>Relative humidity (r.h.)</i> [2] in rooms. The trigger point for the switching function with potential free contacts can be set mechanically. The hygrostat can be used to control → <i>1 step operation</i> [44] or in the → <i>Interlock (safety) system</i> [11] to protect against excess humidity.
Update function	7	The update function provides the control with an update of parameter settings which is stored on an external USB memory stick. The "Update function" parameter is a read-only value which can be used to read out the status of the update.
SI system of units		The system of units with the pressure specified in bar.
Initialisation		The control performs a self-test, during which the welcome screen with the software version is displayed. After the parameter settings and measured values have been read in, the → <i>Main screen</i> [14] is shown on the display.
Interlock (safety) system	11	The hardware interlock (safety) system makes it possible to immediately interrupt steam production, e.g. using an emergency stop button. The interlock (safety) system must be closed to operate the unit. The interlock (safety) system must be implemented on-site with one or several potential free contacts (switched in series). It is connected to the control at terminals 1 and 2, with terminal 1 carrying 230 VAC as standard. In a special design (e.g. for the U.S. market), the interlock (safety) system is converted to low voltage through the additional use of a relay (K21) to meet local safety requirements. Instead of terminals 1 and 2 on the control, a potential free connection of the relevant DIN rail terminals must then be implemented on-site. If the interlock (safety) system is opened, the status of the unit changes to "Interlock (safety) system open".
Software control command	12	Coded command, which is, for example, sent from the building control system or a PLC via the → <i>Communication interface</i> [13] to the control. The command set available is listed in separate documentation, which is available from HygroMatik on request.
Communication interface	13	Serial computer interface for remote control of the unit using, for example, the → <i>Modbus</i> [17] RTU protocol.
Main screen	14	Screen content during the normal operation of the unit. The main screen includes the main display (in the middle of the screen) and the status icons (left and right of the main display).
Modbus	17	Modbus is a communications protocol for serial data transmission for the remote control of units, which is widely used in industry. HygroMatik controls use the MODBUS - RTU (remote terminal unit) variant. Separate documentation is available upon request from HygroMatik.
Flushing of dead-end line	27	When this function is activated, the feed water line is flushed during operation phases in which there are no requests in order to prevent germ formation. For this purpose, the inlet solenoid valve and the flushing solenoid valve are activated at the same time. The "Flushing_of_dead-end_line_interval" parameter determines when flushing starts after a humidification request was not received, the "Flushing_of_dead-end_line_duration" parameter determines how long flushing takes.
Service_main_contactor	34	The operating cycles of the main contactor is recorded by a counter and compared to a factory-set default value by the software. When the default value is reached, the "Service_main_contactor K1" message is displayed on the screen. After the main contactor has been replaced, the counter must be reset with the parameter "Main_contactor_Reset".

Glossary ctd. (1)

Floating max. limiter	35	<p>The floating max. limiter is an additional function when the control is operated with the internal PI controller. It serves for protection against excessive humidification of the channel. In case of the room sensor sending a demand while the channel has already reached its maximum humidity capacity, a floating max. limiter allows for a much more sensitive limitation of the humidification when compared to a max. hygrostat. While the max- hygrostat switches off only when the maximum humidity is reached, the floating max. limiter tracks the humidity progress and turns down the humidification based on a settable control curve until a defined max. humidity is reached. This aims to ensure that no excessive humidification may occur in the channel. To use this function, a 2nd humidity sensor must be mounted in the channel (typical mounting position is the range where the steam is introduced into the channel by the humidifier).</p> <p>Connecting the 2nd humidity sensor The 1st humidity sensor must be of the "Humidity sensor with 0...10 V output voltage" type to allow for the implementation of the floating max. limiter function. The second humidity sensor is than wired to the current input of the mainboard. To allow for this, the sensor must feature a 4...20 mA current output signal.</p> <p>Activating the floating max. limiter Activating is accomplished by setting the "Control settings" parameter in submenu "Control" to "11". If no 2nd humidity sensor is connected, the parameter setting is not saved.</p> <p>Parameter settings for the floating max. limiter For the floating turning-down of the humidity set value, the control curve steepness may be set with the "PI-controller_max_gain" parameter. Factory pre-setting (FP) is "5". The humidity set value for the shut-down point is defined by the "Humidity_set_max" parameter (FP = 80%).</p>
Service_operating_hours	37	<p>The number of hours after which a service is recommended is stored in the control in the "Service-interval_operating_hours" parameter. Once the default value has been reached, the message "Service_operating_hours" is displayed. "Operating_hours_until_message" is used to show the number of hours until the service message is displayed. Once the service has been performed, the service operating hours counter has to be reset with "Operating_hours_reset". This also deletes the service message.</p>
Internal actuator signal	42	<p>Actuator signal for the control of the power element of the unit concerned.</p>
Max. humidification output	43	<p>Reduction of output power to 25... 100% of the nominal output. Can lead to improved control behaviour at lower output requirements.</p>
1-step-operation	44	<p>On/off operation of the High Pressure System without control function through a potential free contact suitable for low voltage, to be supplied on-site. The control can, for example, be implemented using a →Hygrostat [6], which has to be connected to a potential free make contact between terminals 3 and 5 of the control.</p>
Humidification	47	<p>The unit humidifies, if a →Hygrostat [6], an →External control [73], a Humidity sensor or a →Software control command [12] has issued a →Demand [5] and the →Interlock (safety) system [11] is closed.</p>
Correction_x_signal	49	<p>Used for the calibration of a humidity sensor output signal as the →Input signal [72] of the control (x = "V", "mA", "Ω").</p>
Exhaust air cooling	62	<p>Operational mode that is either an made-to-order option or, in case of a →combined system [114], may be selected by setting the "10:Functions/12" parameter (→Digital_input-function [98]). For activating the exhaust air cooling, the →Digital input [97] must be lifted to the →Auxiliary voltage [105] potential. The system then operates in →1-step-operation [44] mode with 100% power output for exhaust air cooling. Practically speaking, instead of using a manually operated switch, it is very common to accomplish the switching by means of a relay-operated NO contact that is controlled by the Business Control System.</p>
Load level	64	<p>The HPS/LPS system distinguishes between different load levels, depending on the number of nozzle sections being controlled. The load levels are differentiated from each other by →switchover points [81] voneinander getrennt.</p>
Relay assignment	65	<p>If the basic relay or additional relays which may be present are not used for signalling but for direct load switching, the maximum contact load 250 VAC/8 A must be taken into account</p>
Output signal	69	<p>Signal 0... 10 V on pins 12 and 13 (GND) of ST07 on the mainboard, which is proportional to the input signal. Can be used to control downstream units.</p>
Input signal	72	<p>The electrical signal fed to the control at the ST08 plug of the mainboard. Depending on the signal characteristic (Voltage, current or resistivity progress), a certain pin of the corresponding plug is used. The signal range of the input signal (e.g. 0...10V) is to be adapted by setting of the related parameter. Using the Correction_x_signal [49] parameters, the output signal of a humidity sensor may be calibrated.</p>
External controller	73	<p>The control uses the output signal of an external controller to control the power element for steam generation. The input level of the control can be adapted to different signal types and value ranges. Other possible input signals are the output signal of a humidity sensor (in connection with the internal PI controller), the switching contact of a →Hygrostat [6] (for →1 step operation [44]) and a →Software command [12] via the →Communication interface [13].</p>
Dropout delay	74	<p>By assigning the "8" value to one of the relay contacts, a delayed control signal is made available for. The dropout delay is set with the "Humidification_off_delay" paramter. Factory default is 60 s.</p>
Main contactor	75	<p>The installed main contactor is labelled K1. The operating cycles of the main contactor is monitored and compared with the value specified by the manufacturer for the expected service life. When the stored value is reached, the message "Service_main_contactor_K1" is generated. After the main contactor has been replaced, the status message must be deleted, using the →Main_contactor_K1_Reset = "1" parameter.</p>

Glossary ctd. (2)

Switchover point	81	Defined switching threshold for switchover from one → <i>load level [64]</i> to an other depending on the input signal level.
Virtual interlock (safety) system	86	If control via → <i>Communication interface [13]</i> was selected, software is used to place a logical switch in series with the hardware interlock (safety) system. This switch can be opened and closed via → <i>Software commands [12]</i> . If the hardware interlock (safety) system is closed and the switch is opened via software control command, steam production is stopped and the unit is placed in "Remote switch-off" status.
Hygiene flushing	87	For hygiene reasons, the controls of the VDI 6022 are set so that flushing must take place at intervals of not longer than 48 h. An interval of < 48 h can be set. The factory setting is 24 h.
Pressure reduction	88	To relieve the pressure system, the solenoid valves to the nozzle sections are opened for the time set in the "Pressure_reduction_duration" parameter while the water supply solenoid valve is closed and the high pressure pump is switched off.
Supply voltage	89	The units are designed for connection to supply voltage ranges (e.g. 380 to 415 VAC in case of a 400 VAC unit, s. name plate)
Unit name	90	Here, "Unit 1" is entered by default.
Recording	93	The control can record 10 data sets internally on a rolling basis. Snapshots of the unit status are carried out at intervals of 10 s, which can be helpful for troubleshooting. When the storage space is filled, a new set of data overrides the oldest entry. The complete record can be saved to a USB stick with NTFS formatting.
PI controller	96	Internal controller with control characteristics which contain a Proportional part and an Integral part. Both parts are variable as parameter settings.
Digital input	97	Digital input on the mainboard and on the relay boards for switching functions. A logical meaning (e.g. timer start) is assigned to the digital input via the → <i>Digital_input_function [98]</i> parameter. The digital input must be wired on-site in accordance with its use, e.g. with a → <i>Pushbutton [106]</i> or a → <i>Switch (NO) [102]</i> against the 20 VDC on terminal 8 on the mainboard terminal strip ST08 or the terminal strip ST05 on the other available boards. When the 20 VDC voltage is applied (short-term via a → <i>Pushbutton [106]</i> or permanent via a → <i>Switch (NO) [102]</i>), as required in accordance with → <i>Digital_input_function [98]</i> parameter setting), the switching function is carried out.
Digital_input_function	98	Determines which function will be executed if the → <i>Digital input [97]</i> on the mainboard or one of the relay boards is activated by applying an → <i>Auxilliary voltage [105]</i> , either short-term (via a push-button) or permanent (via a switch).
Load shedding	101	Load shedding can be set up by assigning the → <i>Function_digital_input [98]</i> "Power limitation" to the → <i>Digital input [97]</i> . When the → <i>Digital input [97]</i> is then then connected to an → <i>Auxilliary voltage [105]</i> by means of a → <i>Switch (NO) [102]</i> , → <i>Max. humidification output [43]</i> is reduced by the percentage set up in the "Δ power limitation" parameter. After withdrawal of the voltage normal operation is reestablished.
Switch (NO)	102	Electrical switch with Normally Open contacts
Auxiliary voltage	105	DC voltage in the range of 5...20V for activating the → <i>Digital input [97]</i> via a → <i>Pushbutton switch [106]</i> or a → <i>Switch [102]</i> . +20 VDC is available on Pin 3 of ST08 (mainboard) or ST05 (relay board). The auxiliary voltage is required to switch the → <i>Digital_input [97]</i> on the mainboard or a relay board in order to trigger the function defined by setting the → <i>Function_digital_input [98]</i> (e.g. switch on ECO mode).
Push button	106	Electrical switch for momentary action
Frequency converter	108	Electronical device for control of the asynchronous motor of the pump group. Pump speed determines the pump pressure.
Pressure controller	109	Integrated → <i>PI controller [96]</i> for pressure control of the system. The control signal of the pressure controller is effective on the → <i>Frequency converter [108]</i> and - consequently - on the pump speed.
Nozzles (status)	110	The spray image of the nozzles may change due to the faintest contamination. In that case cleaning is adequate in a ultrasonic bath (s. maintenance section). If the nozzles are clogged with time by lime deposits, the inner system pressure may rise as compared to the pressure at the time of commissioning without showing any external signs. Control can detect this variation by means of an algorithm.
Load	111	The spray system (e.g. the vortex modules) can be segmented into nozzles that allow for a more delicate humidification control by phased control. The nozzle sections are referred to as "loads" in this document. The switch-over points between the loads are parameterizable.
Supply air humidification	112	Normal system operation
Input signal limitation	113	When using an external controller, the full swing of the → <i>internal actuator signal [42]</i> may be assigned to a cut-off window of the external controller signal swing. By doing so, a better control resolution may be achieved in a particular region. The cut-off window is defined by the parameters "Limitation_ext_X1" (lower value) and "Limitation_ext_X2" (upper value).
Combined system	114	This particular made-to-order-system allows the switch from → <i>Supply air humidification [112]</i> to → <i>Exhaust air cooling [62]</i> . Switching is usually controlled by the Building Control System via a relay contact or through an other on-site switching device.

HygroMATIK®

Lise-Meitner-Str.3 • D-24558 Henstedt-Ulzburg
Phone +49(0)4193/ 895-0 • Fax -33
eMail hy@hygromatik.de • www.hygromatik.com
member of **CAREL Group**

